

Vinyl Express Qe60+

CUTTING PLOTTER

USER'S MANUAL

MANUAL NO. VEXQe6+-UM-151



Signwarehouse.com

PREFACE

Thank you for choosing a Signwarehouse Vinyl Express Series cutting plotter. The Vinyl Express cutting plotters employ a digital servo drive system to achieve high-speed, high-precision cutting. In addition to cutting marking film and other media, a Vinyl Express Series cutting plotter can also be used as a pen plotter. To ensure high cutting quality and optimal productivity, be sure to read this User's Manual thoroughly prior to use.

Notes on this Manual

- (1) No part of this publication may be reproduced, stored in a retrieval system, or transmitted, in any form or by any means, without the prior written permission of Signwarehouse.com.
- (2) The product specifications and other information in this manual are subject to change without notice.
- (3) While every effort has been made to provide complete and accurate information, please contact your sales representative or nearest Signwarehouse.com vendor if you find any unclear or erroneous information or wish to make other comments or suggestions.

Notwithstanding the stipulations in the preceding paragraph, Signwarehouse.com assumes no liability for damages resulting from either the use of the information contained herein or the use of the product.

Registered Trademarks

All names of companies, brands, logotypes, and products appearing in this manual are the trademarks or registered trademarks of their respective companies.

Copyright

This User's Manual is copyrighted by Signwarehouse.com.

Contents

| | |
|--|------|
| PREFACE | i |
| Notes on this Manual | i |
| Registered Trademarks | i |
| Copyright | i |
| Contents | iii |
| | |
| 1. INTRODUCTION | |
| 1.1 Checking the Accessories | 1-2 |
| 1.2 Parts Names and Functions | 1-3 |
| Front View | 1-3 |
| Rear View | 1-3 |
| Control Panel..... | 1-4 |
| | |
| 2. SETTING UP THE CUTTER PLOTTER | |
| 2.1 Connecting to Your Computer | 2-2 |
| 2.2 Turning on the Power | 2-3 |
| 2.3 Loading the Medium | 2-4 |
| Loading a Roll Medium..... | 2-4 |
| Loading Sheet Media..... | 2-7 |
| Aligning the Push Rollers | 2-8 |
| 2.4 Adjusting and Mounting the Cutter Pen | 2-10 |
| Types and Features of Cutter Blades..... | 2-10 |
| Cutter-Pen Construction..... | 2-11 |
| Replacing the Cutter Blade..... | 2-11 |
| Adjusting the Blade Length..... | 2-12 |
| Mounting a Cutter Pen..... | 2-13 |
| | |
| 3. BASIC SETTINGS AND OPERATIONS | |
| 3.1 Setting the Format of Data to be Received | 3-2 |
| Setting the Command Mode..... | 3-2 |
| Setting the STEP SIZE..... | 3-3 |
| Setting the ORIGIN POINT..... | 3-3 |
| 3.2 Setting the Interface Conditions | 3-4 |
| 3.3 Setting the Cutter-Pen Conditions | 3-5 |
| Selecting Cutter-Pen-Condition Setting Areas | 3-6 |
| Storing Cutter-Pen-Condition Setting Areas..... | 3-6 |
| Setting TOOL (cutter blade or pen) | 3-7 |
| Setting OFFSET | 3-7 |
| Setting FORCE..... | 3-8 |
| Setting SPEED | 3-8 |
| Setting QUALITY | 3-9 |
| 3.4 Displaying the Effective Cutting Area | 3-9 |
| 3.5 Moving the Pen | 3-9 |
| 3.6 Setting the Initial Cutting Position | 3-10 |
| 3.7 Stop Function | 3-11 |
| 3.8 Moving the Pen Carriage in +100 mm Steps | 3-12 |

| | | |
|---|--|------|
| 3.9 | Test Cutting..... | 3-12 |
| 4. FUNCTION SETTINGS AND OPERATIONS | | |
| 4.1 | PAUSE Menu List | 4-2 |
| 4.2 | Reading the Auto Registration Marks (Option) | 4-3 |
| 4.3 | Setting the FEED function | 4-4 |
| 4.4 | Setting AUTO PRE-FEED | 4-5 |
| 4.5 | Setting TANGENTIAL Mode..... | 4-6 |
| 4.6 | Auto-Registration-Mark-Reading Settings (Option) | 4-8 |
| | Registration-Mark Menu Tree..... | 4-10 |
| | Setting the Registration-Mark Mode | 4-11 |
| 4.7 | Clearing the Buffer Memory | 4-22 |
| 4.8 | Aligning the Coordinate Axes | 4-23 |
| 4.9 | Distance Adjustment..... | 4-25 |
| 4.10 | Setting the PAGE LENGTH..... | 4-27 |
| 4.11 | Setting the Cutting/Plotting Area | 4-28 |
| 4.12 | Expanding the Cutting/Plotting Area..... | 4-29 |
| 4.13 | Rotating the Coordinate Axes | 4-30 |
| 4.14 | Mirroring..... | 4-31 |
| 4.15 | Cutting/Plotting Using the Buffer Memory | 4-32 |
| 4.16 | Sorting Settings..... | 4-34 |
| 4.17 | Interface Settings | 4-35 |
| 4.18 | Setting the Format of Data to be Received | 4-36 |
| | Setting the Command Mode..... | 4-36 |
| | Setting the STEP SIZE | 4-37 |
| | Setting the ORIGIN POINT..... | 4-37 |
| 4.19 | Blade Wear Detection..... | 4-38 |
| | Checking the Wear Rate | 4-38 |
| | Setting Wear-Rate Groups | 4-39 |
| | Setting Wear-Rate Factors | 4-40 |
| | Clearing the Total Distance (Wear Rate)..... | 4-40 |
| 4.20 | Raising and Lowering the Pen | 4-42 |
| 4.21 | TEST Mode | 4-43 |
| | Condition-List Printing | 4-43 |
| | Dump Mode | 4-44 |
| | Cutting Force Test Cutting..... | 4-45 |
| 4.22 | Setting the PEN UP SPEED | 4-47 |
| 4.23 | Setting the OFFSET FORCE | 4-48 |
| 4.24 | Setting the OFFSET ANGLE | 4-49 |
| 4.25 | Setting the STEP PASS..... | 4-50 |
| 4.26 | Setting the Initial Down Force | 4-51 |
| 4.27 | Setting the LENGTH UNIT..... | 4-52 |
| 5. Setting and Using the Special Functions | | |
| 5.1 | Description of Special Functions A | 5-2 |
| | Enabling/Disabling the “:” and “;” Commands (when the COMMAND setting is GP-GL) .. | 5-2 |
| | Moving the Pen While Raised or Lowered in Response to the “W” Command (when the COMMAND setting is GP-GL) | 5-2 |
| | Model ID Response (when the COMMAND setting is HP-GL)..... | 5-2 |
| | SETTING PRIORITY | 5-2 |

| | | |
|------------|--|-----|
| | Blade-Tip Initial Position Setting..... | 5-2 |
| | Enabling/Disabling PEN UP MOVE..... | 5-3 |
| | Enabling/Disabling the Media Sensors..... | 5-3 |
| | Enabling/Disabling the Home Sensors..... | 5-3 |
| | Circle-Command Resolution Setting (when the COMMAND setting is HP-GL)..... | 5-3 |
| | Enabling/Disabling Blade Wear Detection..... | 5-3 |
| 5.2 | Setting Special Functions A | 5-4 |
| 5.3 | Description of Special Functions B | 5-4 |
| | Display Language Setting (MENU LANGUAGE SELECTION)..... | 5-4 |
| 5.4 | Setting Special Functions B | 5-5 |

6. TROUBLESHOOTING

| | | |
|------------|--|-----|
| 6.1 | The Cutting Plotter Does Not Operate When Turned On | 6-2 |
| 6.2 | The Cutting Plotter Does Not Operate Correctly | 6-2 |
| 6.3 | The Cutting Results Are Unsatisfactory | 6-3 |
| 6.4 | An Error Message Was Displayed | 6-5 |

APPENDIX

| | | |
|-------------------|-----------------------------------|-----|
| Appendix A | Main Specifications | A-2 |
| Appendix B | Options and Supplies | A-3 |
| Appendix C | External Dimensions | A-4 |
| Appendix D | Menu Tree | A-5 |

INDEX

1

INTRODUCTION

| | | |
|------------|--|------------|
| 1.1 | Checking the Accessories | 1-2 |
| 1.2 | Parts Names and Functions | 1-3 |

1.1 Checking the Accessories

Check to confirm that all of the standard accessories listed below are present. If any item is missing, please contact your sales representative or nearest Signwarehouse vendor promptly.

AC power cord

1

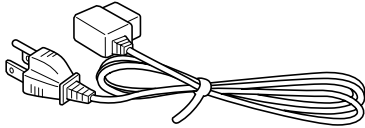

Quick Start Manual, Usage Precautions

1 each

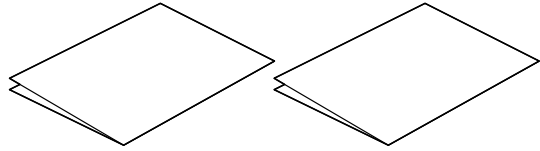

User Guide CD-ROM

1

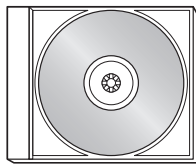

Cutter blade (CB09UA)

1

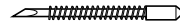

Cutter plunger

1

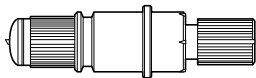

Media cutter

1

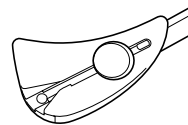

Water-based fiber-tip pen

1

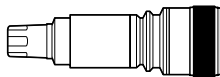

Stand

1

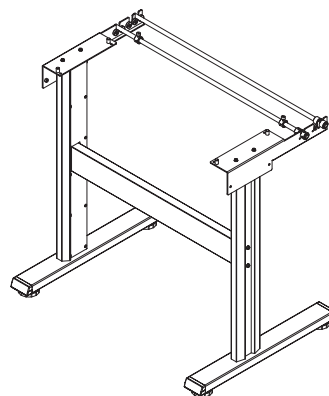

USB cable

1

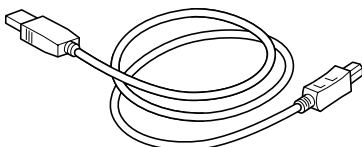

1.2 Parts Names and Functions

■ Front View

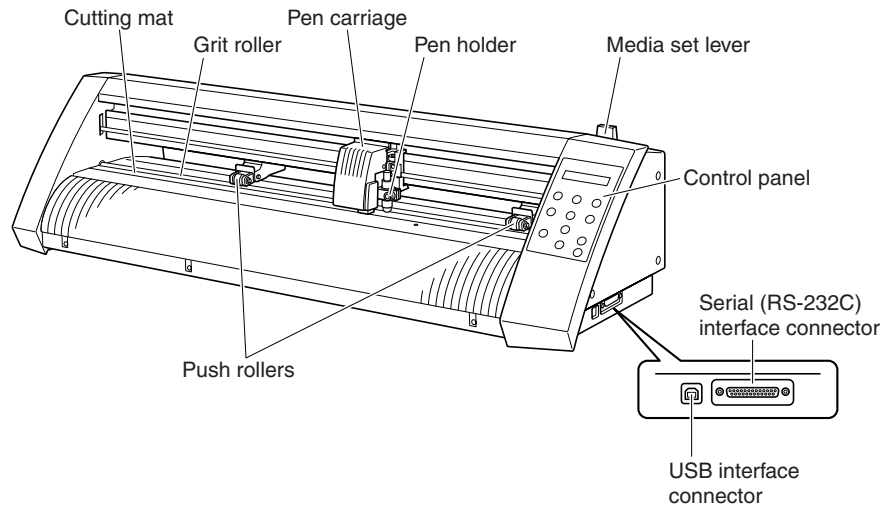

| | |
|---|--|
| Cutting mat | : Cutting or plotting is performed on this mat. |
| Grit roller | : Feeds the medium backward or forward |
| Push rollers | : Pushes the medium against the grit rollers |
| Pen carriage | : Moves the cutter pen to the left and right |
| Pen holder | : Holds the cutter pen and moves it up and down |
| Media set lever | : Raises or lowers the push rollers during loading of a medium |
| Control panel | : Used to operate the cutting plotter and set functions |
| USB interface connector | : Used to connect a USB cable |
| Serial (RS-232C) interface connector | : Used to connect an RS-232C serial interface cable |

■ Rear View

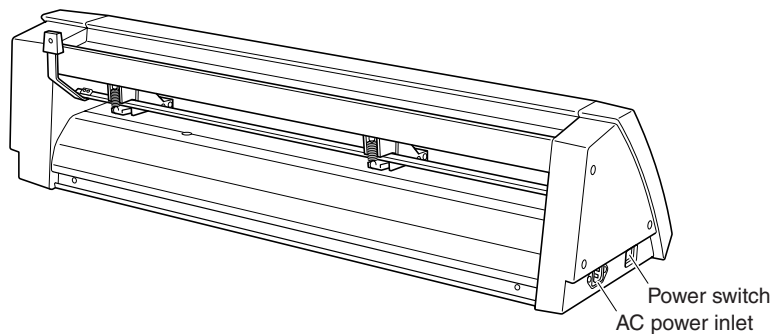

| | |
|-----------------------|---|
| AC power inlet | : Connects the power cord to the cutting plotter |
| Power switch | : Turns the power supply to the cutting plotter on or off |



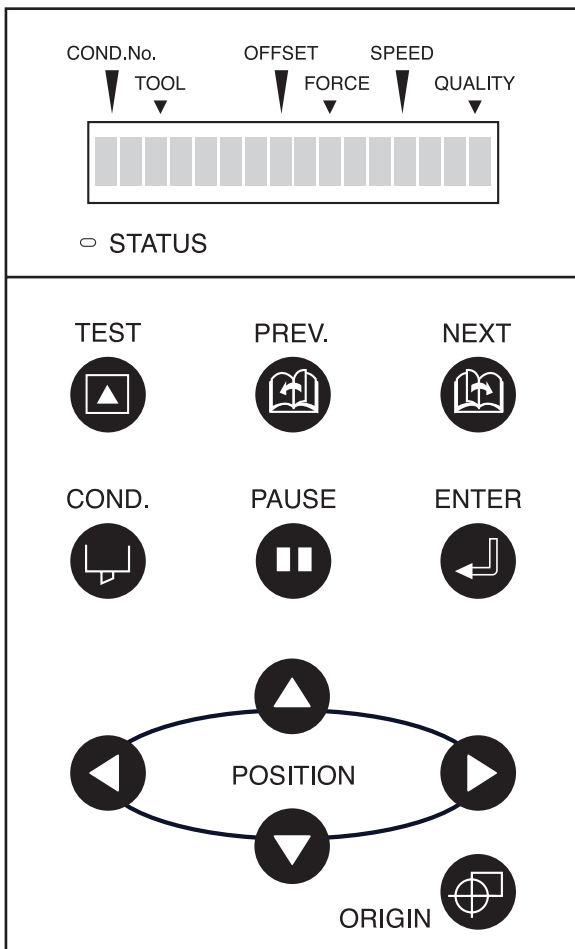







■ Control Panel



Indicator Lamp

STATUS: Lights (green) while the power to the cutting plotter is turned on, and is not lit when the cutting plotter is in PAUSE status. This lamp flashes when data is being received from an interface, regardless of whether or not the cutting plotter is in PAUSE status.

Panel Keys

-  **TEST:** Press this function key to conduct a cutting test and check the cutting conditions.
-  **PREV.:** Press this function key to view the previous display on the LCD when in PAUSE status.
-  **NEXT:** Press this function key to view the next display on the LCD when in PAUSE status.
-  **COND.:** Press this function key to view the cutter-pen condition settings.
-  **PAUSE:** Press this function key once in READY status to switch to PAUSE status in order to change the various settings (see “4.1 PAUSE Menu List”). Press it again to cancel the PAUSE status. Pressing this key while cutting or plotting is in progress stops the cutting or plotting (see “3.7 Stop Function”).
-  **ENTER:** Pressing this function key registers the cutting or plotting conditions set.
-     **POSITION:** These keys are used to move the cursor or change the settings on the LCD display on the function setting screens. Press these keys when in PAUSE status to move the pen carriage or the medium.
-  **ORIGIN:** Press this function key to set the origin point. The pen position is set as the origin point when this key is pressed.

2

SETTING UP THE CUTTER PLOTTER

| | | |
|------------|---|-------------|
| 2.1 | Connecting to Your Computer..... | 2-2 |
| 2.2 | Turning on the Power | 2-3 |
| 2.3 | Loading the Medium..... | 2-4 |
| 2.4 | Adjusting and Mounting the Cutter Pen..... | 2-10 |

2.1 Connecting to Your Computer

The cutting plotter can be connected to a computer via the serial (RS-232C) port or USB port. Select which port to use according to the requirements of your application software and/or which of your computer's interface ports are available for use.

Use a serial cable or USB cable in accordance with the connection method chosen. Obtain a Graphtec-approved interface cable that is compatible with the selected interface port (an RS-232C cable can be purchased separately; a USB cable is provided as a standard accessory).

Step 1

Check to confirm that the Power switch is turned off (the "O" side is down).

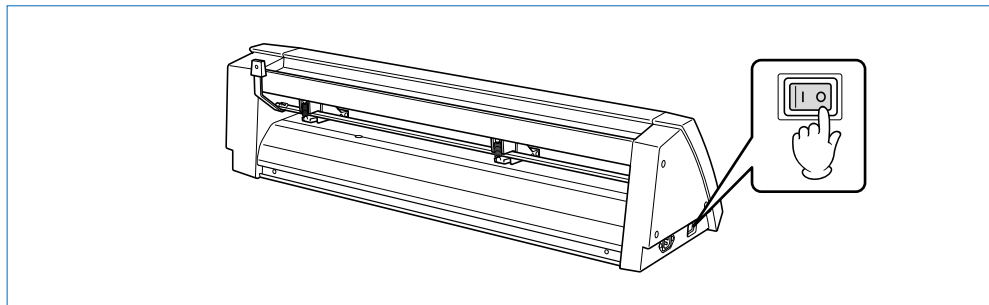

Step 2

Connect the cable between the cutting plotter and the computer. Make sure the connectors at the cutting plotter and computer ends are correctly oriented.

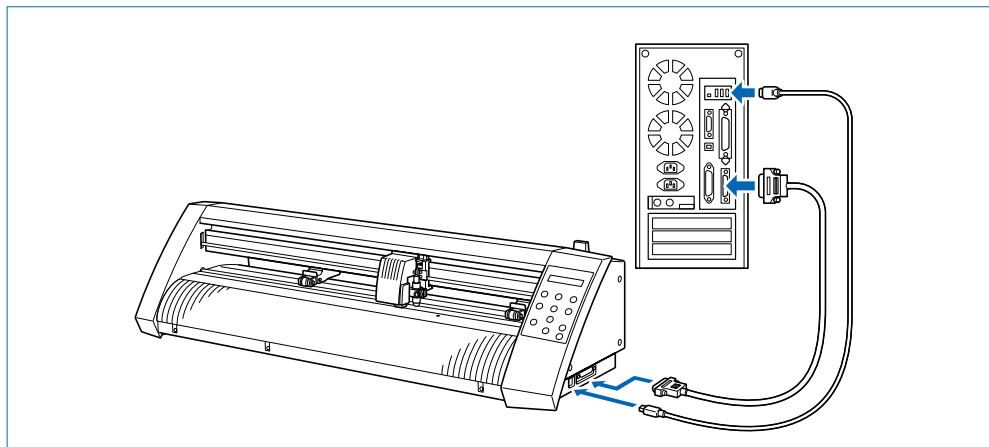

2.2 Turning on the Power

Connect the cutting plotter to the AC electrical socket using the power cord provided, and turn on the power.

Step 1

Check to confirm that the Power switch is turned off (the “O” side is down).

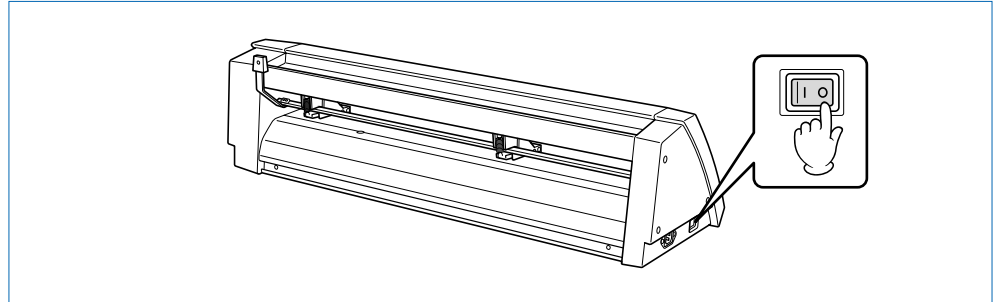

Step 2

Connect the cutting-plotter AC power inlet to a correctly rated electrical socket using the power cord provided.

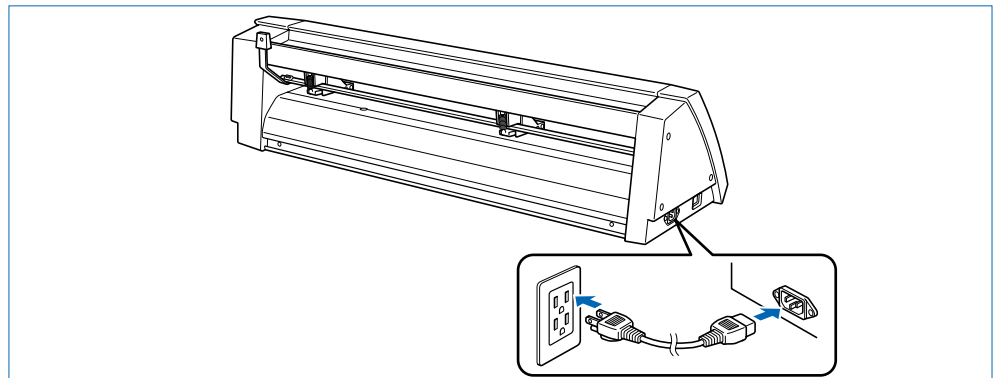

Step 3

Turn on the cutting plotter by pressing the “I” side of the Power switch. The STATUS lamp on the control panel will light up.

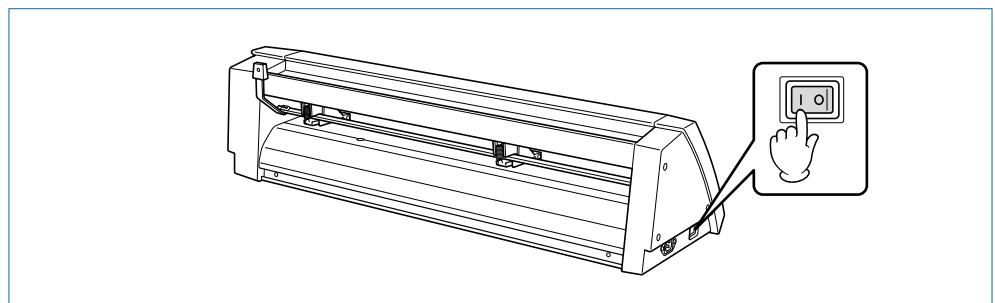

Step 4

If no medium has been loaded, the message below appears on the display, prompting the loading of a medium.

LOAD MEDIA!!

If a medium has already been loaded, the current media setting is displayed as shown below.

ROLL2 PRESS ENTR

Select the media mode to suit the medium used. For instructions on loading media and selecting the media mode, see “2.3 Loading the Medium.”

2.3 Loading the Medium

Load the medium, aligning it with the right-hand grit roller when viewed from the front so that it registers with the media sensor. Then, adjust the push-roller position to match the width of the medium. The cutting plotter can use media in roll or sheet form. Load the desired medium type by following the appropriate instructions.

■ Loading a Roll Medium

Load the roll medium onto the stand stock rollers.

Placing on the Stand

Step 1

Fit the stoppers to one of the stock rollers (loosen the screws on the stoppers first).

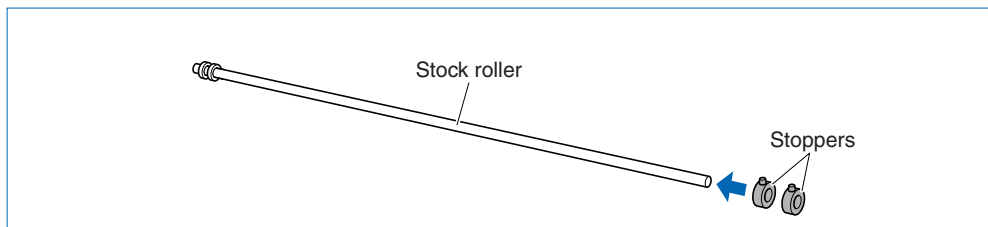

Step 2

Position the stock roller with the stoppers towards the front, and place the other stock roller toward the rear to suit the roll-medium size.

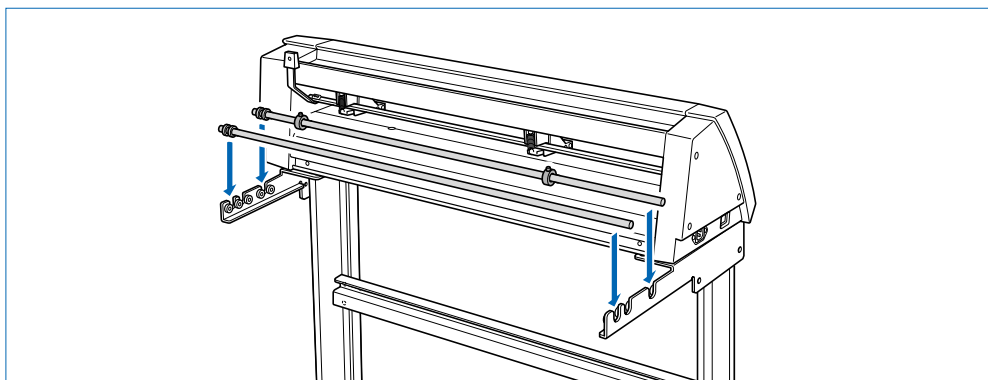

Step 3

Place the roll medium on the stock rollers, and clamp it between the stoppers. Once the position is fixed, tighten the screws on the stoppers.

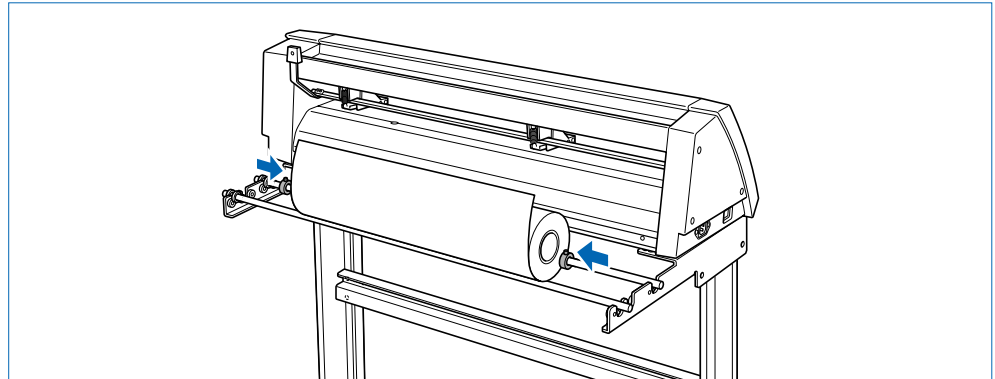

Loading the Roll Medium

Step 1

Lower the media set lever to raise the push rollers.

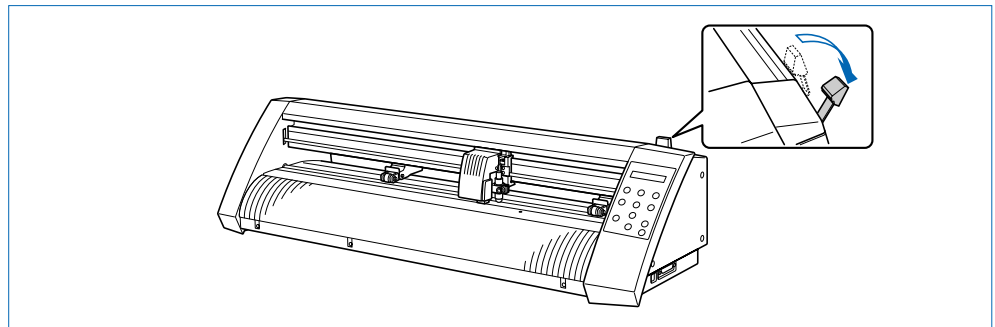

Step 2

Place the roll medium on the stand stock rollers, and then pass the leading edge of the medium from the back of the cutting plotter so it emerges from the front, while making sure to remove any slack in the medium conveyance path.

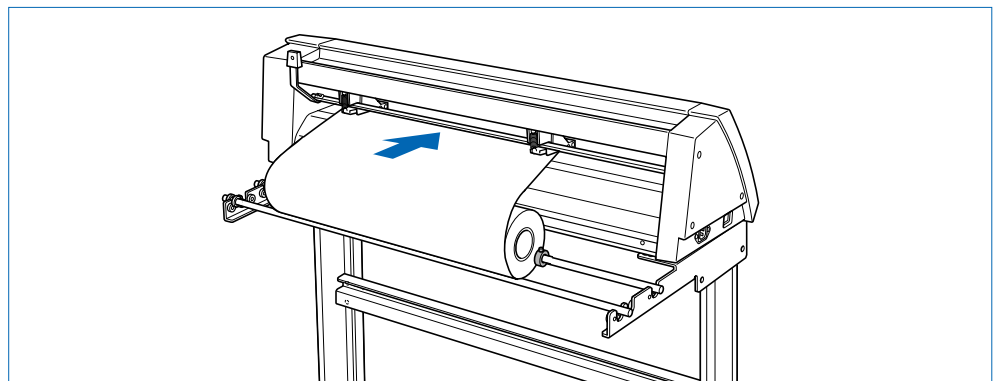

Step 3

Pull the leading edge out of the front of the cutting plotter so that it completely covers the media sensor. If the leading edge has been pulled out too far, turn the roll to adjust the length of the medium that is protruding.

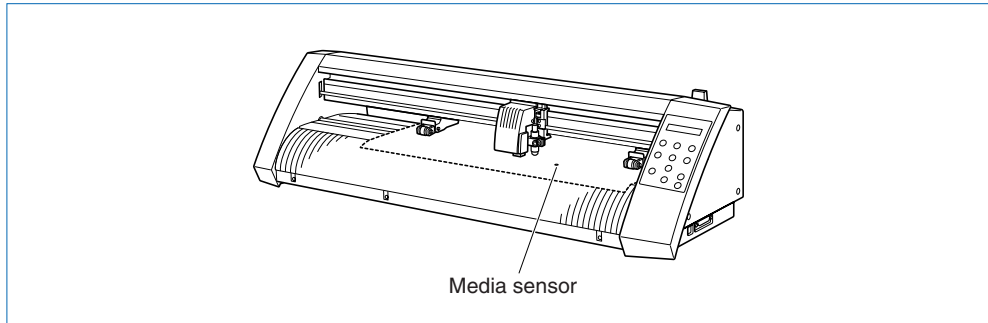

CHECKPOINT

Load the medium so that it passes over the media sensor.

Step 4

Adjust the position of the left- and right-hand push rollers to suit the width of the roll medium.

Step 5

After ensuring that there is no slack in the medium's conveyance path, raise the media set lever to lower the push rollers and provide slack in the medium for a length corresponding to the length of the medium to be used.

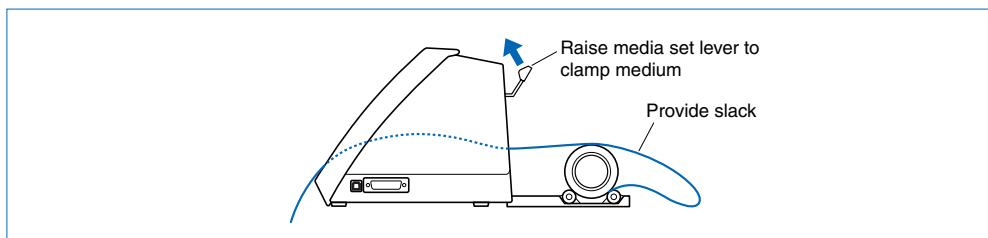

Step 6

Raising the media set lever displays a menu for selection of the media mode. Select the media mode.

ROLL2 PRESS ENTR

CHECKPOINT

If the “**REALIGN ROLLERS**” message is displayed when the medium is loaded and the media set lever is raised, either the right-hand push roller is not positioned over the right-hand wide grit roller or the left-hand push roller is not positioned over the grit roller. Check to confirm that they are positioned correctly.

Step 7

Pressing the ▲ or ▼ key displays “ROLL1 PRESS ENTR”, “ROLL2 PRESS ENTR”, and “SHEET PRESS ENTR”. Select “ROLL2 PRESS ENTR” or “ROLL1 PRESS ENTR” and then press the ⏏ (ENTER) key to confirm. When “ROLL2 PRESS ENTR” is selected, only the medium width is detected. Select this mode to begin cutting at a point beyond the leading edge. When “ROLL1 PRESS ENTR” is selected, the leading edge and width of the medium are detected. Select this mode to begin cutting from the leading edge.

Step 8

After the medium size has been detected, the pen carriage returns to the origin point and the cutting plotter awaits cutting data. If the INTERFACE conditions or COMMAND mode have not yet been set, they should be set. If they have already been set, adjust the cutter pen. Once the cutter pen has been adjusted, the cutting plotter is ready to perform cutting, so cutting data can be sent from the application software on the computer.

■ Loading Sheet Media

Step 1

Lower the media set lever to raise the push rollers.

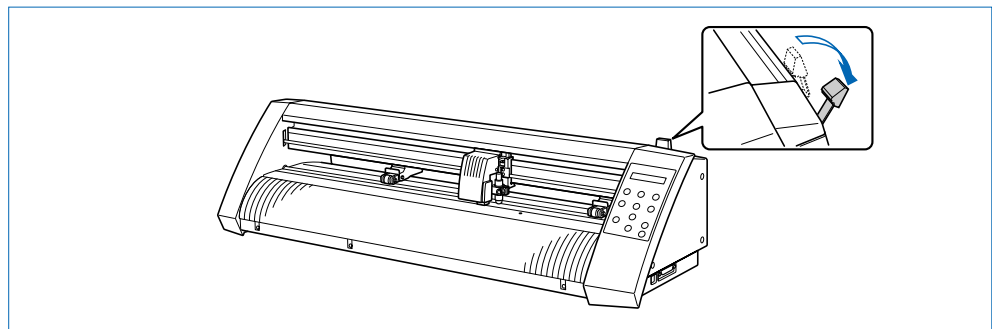

Step 2

With the Vinyl Express, position the edges of the medium flush against the guide lines engraved on the front guide.

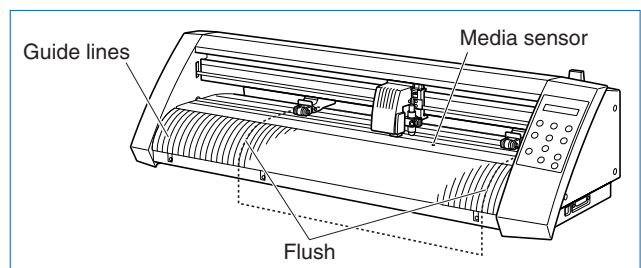

CHECKPOINT

Load the medium so that it passes over the media sensor.

Step 3

Adjust the position of the left- and right-hand push rollers to suit the medium width.

Step 4

Raising the media set lever displays a menu for selecting the media mode. Select the media mode.

SHEET PRESS ENTR

CHECKPOINT

If the “**REALIGN ROLLERS**” message is displayed when the medium is loaded and the media set lever is raised, either the right-hand push roller is not positioned over the right-hand wide grit roller, or the left-hand push rollers are not positioned over the grit roller. Check to confirm that they are positioned correctly.

Step 5

Pressing the ▲ or ▼ key displays “**ROLL1 PRESS ENTR**”, “**ROLL2 PRESS ENTR**”, and “**SHEET PRESS ENTR**”. Select “**SHEET PRESS ENTR**” and then press the ⏎ (**ENTER**) key to confirm the selection. When “**SHEET PRESS ENTR**” is selected, the front and rear edges are detected.

Step 6

After the medium size has been detected, the pen carriage returns to the origin point and the cutting plotter awaits cutting data. If the INTERFACE conditions or COMMAND mode have not yet been set, they should be set. If they have already been set, adjust the cutter pen. Once the cutter pen has been adjusted, the cutting plotter is ready to perform cutting, so cutting data can be sent from the application software on the computer.

■ Aligning the Push Rollers

Adjust the position of the left- and right-hand push rollers to suit the medium width. Position the push rollers at either edge of the medium so that they are above the grit rollers. Adjust the push rollers so that they are positioned above both the medium and the grit rollers. Positioning the push rollers within the push-roller alignment marks ensures that they are above the grit rollers.

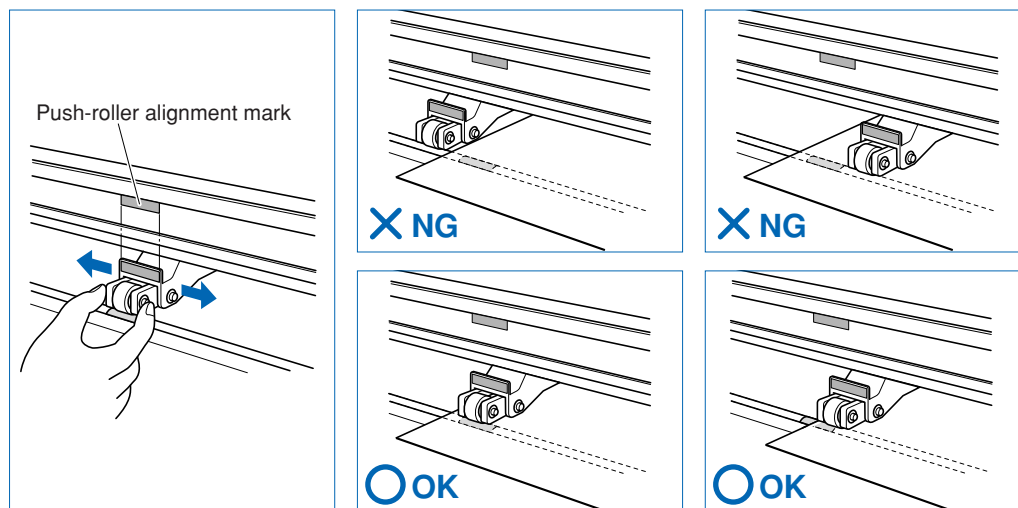

CAUTION To move the push rollers, the media set lever must be in the lowered position.

The push roller on the right-hand edge when viewed from the front must always be moved over the right-hand wide grit roller.

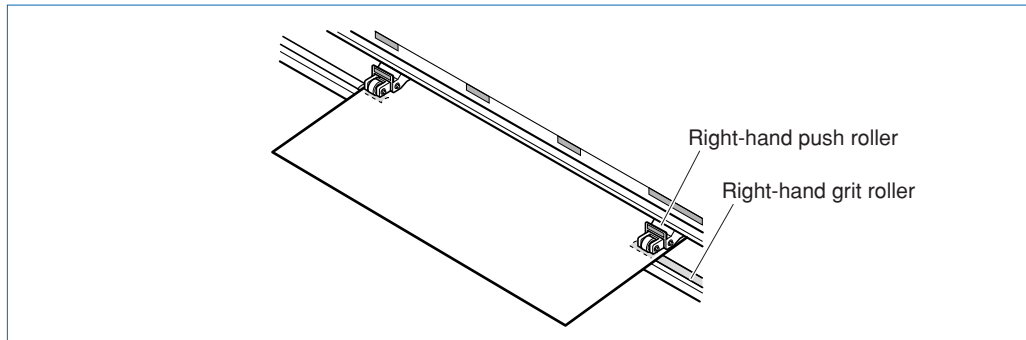

CAUTION To move the push rollers, the media set lever must be in the lowered position.

CHECKPOINT

If the “**REALIGN ROLLERS**” message is displayed when the medium is loaded and the media set lever is raised, either the right-hand push roller is not positioned over the right-hand wide grit roller, or the left-hand push roller is not positioned over the grit roller. Check to confirm that they are positioned correctly.

Position the push rollers over the grit rollers to grip each edge of the medium.

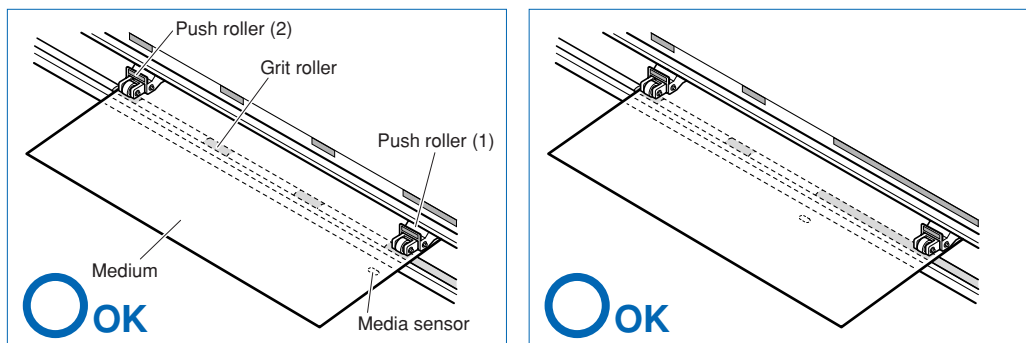

CAUTION

- The push roller (1) must be positioned over the right-hand wide grit roller.
- The medium must always be positioned over the media sensor.

For Minimum-Size Media

Position all of the rollers over the right-hand wide grit roller. Position the medium with the left-hand edge aligned with the left-hand edge of the grit roller, and position the push rollers over both edges. The minimum width of the medium that can be set is 50 mm for the Vinyl Express.

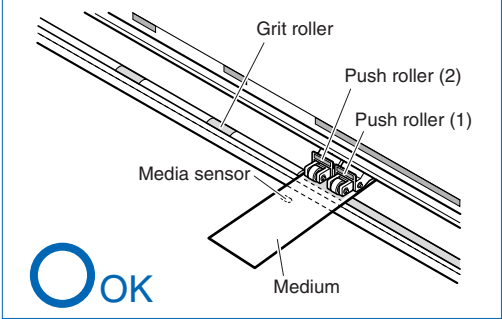

- CAUTION**
- The medium must be at least 125 mm in length.
 - The medium must always be positioned over the media sensor.

2.4 Adjusting and Mounting the Cutter Pen

Individual cutter blades have a variety of features. Select the optimal cutter blade to suit the medium to be cut.

- CAUTION** To avoid cutting your fingers, always handle the cutter blade with caution.

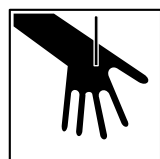

Types and Features of Cutter Blades

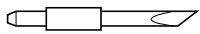
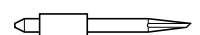
| Part No. and profile | Blade diameter and offset | Compatible plunger | Use and features |
|--|------------------------------|--------------------|--|
| CB 09UA  | \varnothing 0.9 mm 0.45 | PHP32-CB09N | The standard blade for cutting color adhesive-backed media. Suitable for cutting media up to 0.25 mm in thickness. Max. cutting distance: Approx. 4,000 m |
| CB 15U  | \varnothing 1.5 mm 0.75 | PHP32-CB15N | Capable of cutting thicker media than possible with the CB09UA blade. Suitable for cutting media 0.25 mm to 0.5 mm in thickness. |
| CB 15UB  | \varnothing 1.5 mm 0.15 | PHP32-CB15N | Suitable for detailed cutting (e.g., letters less than 10 mm in size) of media up to 0.25 mm in thickness. |

■ Cutter-Pen Construction

The cutting plotter cuts using a cutter blade mounted in a cutter-pen plunger. There are two different cutter-pen plungers to suit the diameter of the cutter blade to be mounted (the 0.9-mm cutter-pen plunger is provided as standard equipment). Be sure to mount the cutter blade in the corresponding cutter-pen plunger.

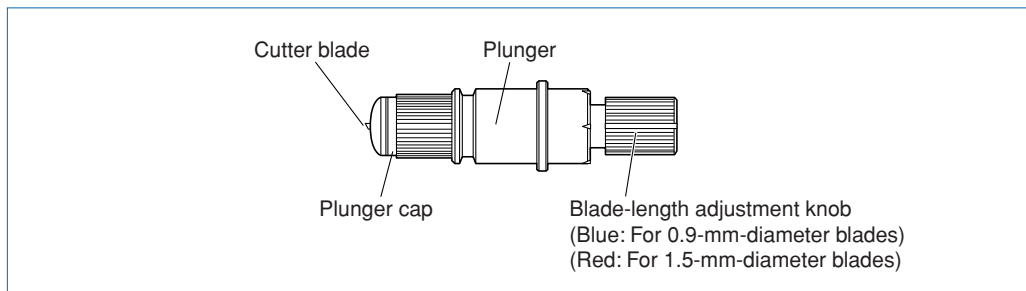

■ Replacing the Cutter Blade

⚠ CAUTION To prevent cutting your fingers, always handle the cutter blade with caution.

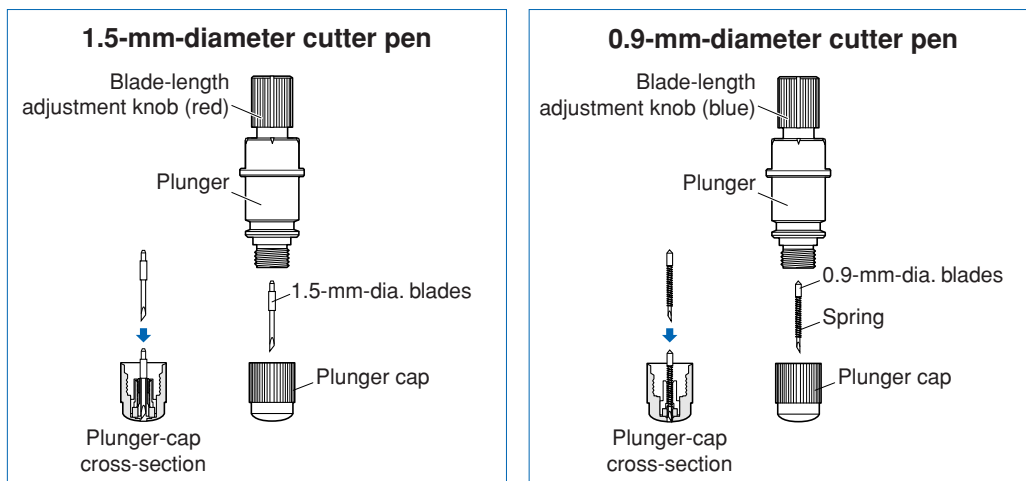

Step 1

Turn the blade-length adjustment knob to retract the blade into the plunger.

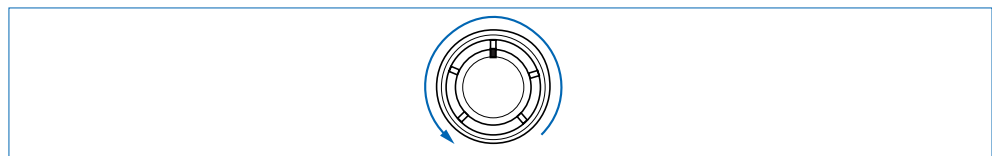

Step 2

Turn the plunger cap in the counter-clockwise direction to remove it from the plunger.

Step 3

Remove the blade from inside the plunger cap.

Step 4

Insert the new blade into the hole provided in the plunger cap.

Step 5

With the blade inserted into the plunger cap, screw on the plunger from above.

■ Adjusting the Blade Length

If the blade is extended too far in relation to the thickness of the medium being cut, it will damage the cutting mat. Be sure to adjust the blade length correctly.

⚠ CAUTION To prevent cutting your fingers, always handle the cutter blade with caution.

Step 1

Adjust the blade length by turning the blade-length adjustment knob. Turn the knob in direction “**A**” to extend the blade, or in direction “**B**” to retract the blade. When the knob is turned by one scale unit, the blade moves approximately 0.1 mm. One full turn of the knob moves the blade approximately 0.5 mm.

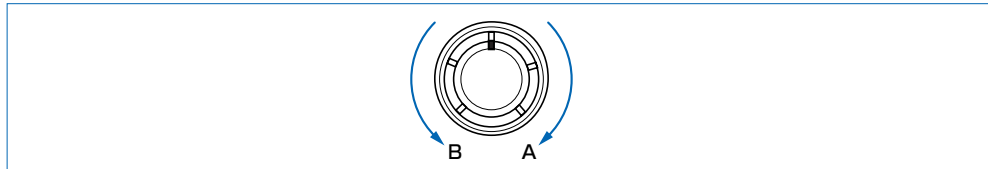

Step 2

First align the blade tip with the tip of the cutter pen, and then extend the blade from that position to suit the thickness of the media to be cut.

Step 3

Assuming that the medium thickness is “**t**,” as shown in the figure below, the blade length “**ℓ**” should be equal to or slightly greater than “**t**.” Make sure “**ℓ**” is never greater than the combined thickness of the medium and its backing sheet. If it is not possible to accurately determine the medium thickness, adjust the blade length by gradually increasing it until only traces of the blade appear on the backing sheet after a cutting test is conducted.

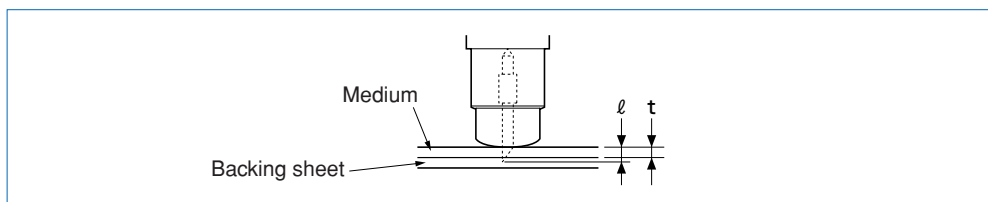

■ Mounting a Cutter Pen

Adjust the blade to the correct length before mounting the cutter pen.

⚠ CAUTION Take care not to cut your fingers on the cutter blade when handling the cutter pen.

Step 1

Loosen the pen holder screw.

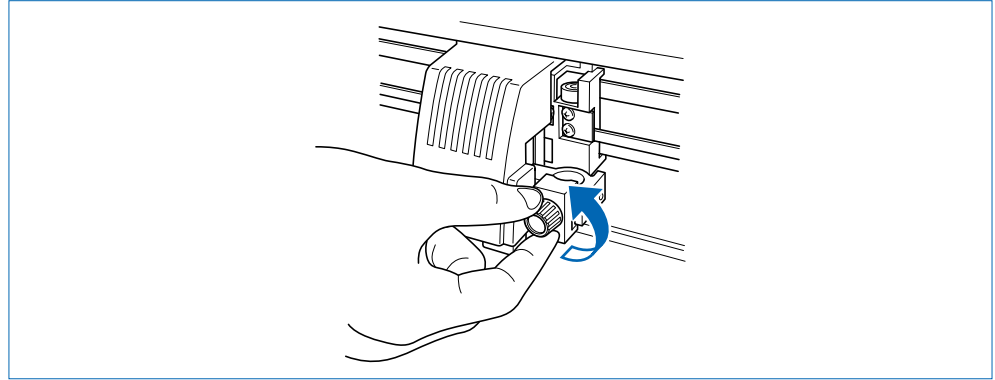

Step 2

While pushing the pen holder in the upward direction, push the pen all the way into the holder until its flange contacts the upper part of the holder. Make sure that the pen bracket is engaged on the pen's flange.

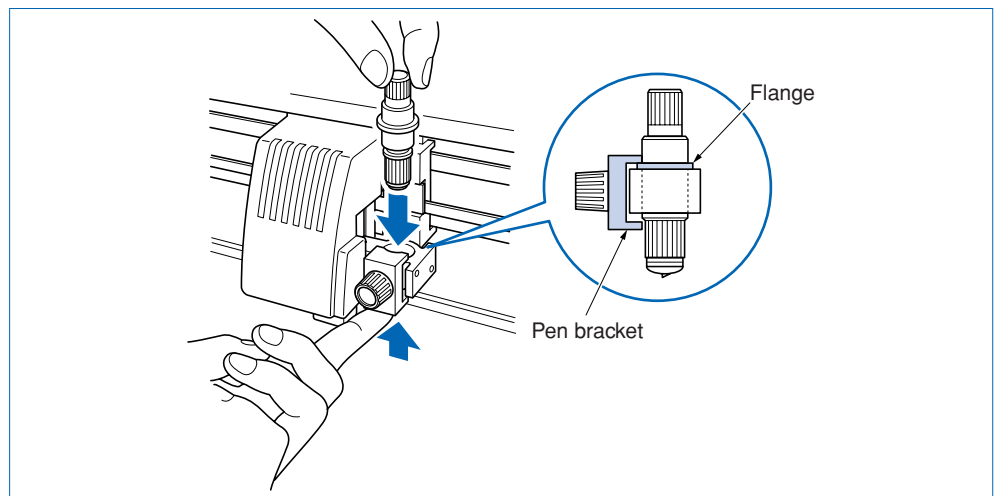

⚠ CAUTION When you push the pen holder up with your fingers, take care not to cut your fingers on the cutter blade.

Step 3

When the cutter pen has been mounted, tighten the screw to hold it in place.

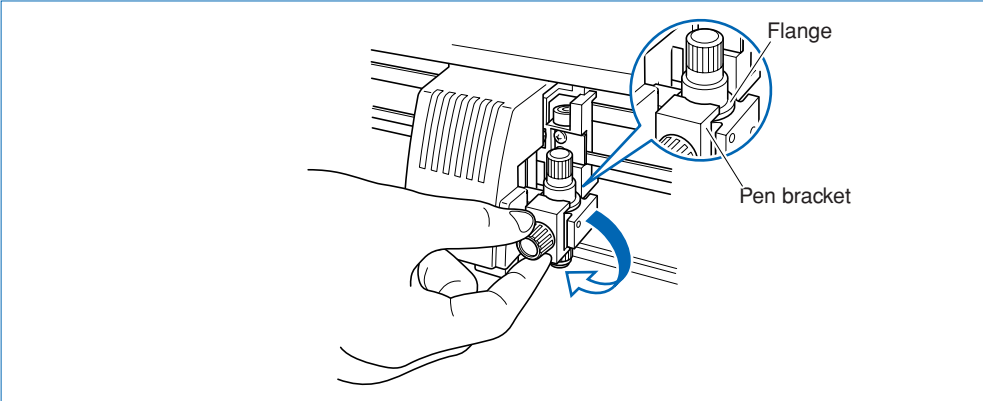

3

BASIC SETTINGS AND OPERATIONS

| | | |
|------------|--|-------------|
| 3.1 | Setting the Format of Data to be Received | 3-2 |
| 3.2 | Setting the Interface Conditions | 3-4 |
| 3.3 | Setting the Cutter-Pen Conditions | 3-5 |
| 3.4 | Displaying the Effective Cutting Area | 3-9 |
| 3.5 | Moving the Pen..... | 3-9 |
| 3.6 | Setting the Initial Cutting Position (Origin Point) | 3-10 |
| 3.7 | Stop Function | 3-11 |
| 3.8 | Moving the Pen Carriage in +100 mm Steps..... | 3-12 |
| 3.9 | Test Cutting | 3-12 |

3.1 Setting the Format of Data to be Received

Before data is sent from the computer, the format (command mode) of the data sent by the application software must be checked. The cutting plotter accepts two data formats (command modes): GP-GL (Graphtec) and HP-GL commands. Set the command mode to suit the application used.

■ Setting the Command Mode

Step 1

Check to confirm that the cutting plotter is in READY mode (displaying the current pen settings).

1 PEN 12 30 2

Step 2

Press the **⏸ (PAUSE)** key to switch to PAUSE mode, and then press the **⏪ (NEXT)** or **⏩ (PREV.)** key until the menu shown below is displayed.

COMMAND

Step 3

Press the **⏴ (ENTER)** key to display the menu shown below.

COMMAND HP-GL

Step 4

Press the **▲** or **▼** key to select “GP-GL” or “HP-GL,” and then press the **⏴ (ENTER)** key to confirm. To cancel the selection, press the **⏪ (NEXT)** or **⏩ (PREV.)** key.

Step 5

If “GP-GL” is selected, set the STEP SIZE. If “HP-GL” is selected, set the ORIGIN POINT. If a different command from that set previously is selected, the PAUSE mode is automatically cancelled once the STEP SIZE (GP-GL) or ORIGIN POINT (HP-GL) is set.

■ Setting the STEP SIZE

If the GP-GL command mode is set, it is possible to change the minimum unit of distance that the cutter pen or pen can travel to one of four settings: 0.01 mm, 0.025 mm, 0.05 mm, or 0.1 mm. The default setting is 0.1 mm, so this setting should be changed if your application specifies a different step size.

Step 1

Set the command setting to “GP-GL.”





COMMAND GP - GL

Step 2

Press the  (ENTER) key to display the step-size setting.

STEP SIZE 0.100mm

Step 3

Press the  or  key to select “0.100 mm,” “0.050 mm,” “0.025 mm,” or “0.010 mm,” and then press the  (ENTER) key to confirm. To cancel the selection, press the  (NEXT) or  (PREV.) key.

Step 4

Press the  (PAUSE) key to cancel PAUSE mode.

■ Setting the ORIGIN POINT

If the HP-GL command mode is set, the origin point can be set to the lower left or center. The default setting is the lower left, so this setting should be changed if your application specifies a different origin position.

Step 1

Set the command setting to “HP-GL.”

COMMAND HP - GL

Step 2

Press the  (ENTER) key to display the origin-point setting.

ORIGIN PT L.L.

Step 3

Press the  or  key to select “L.L. (LOWER LEFT)” or “CENTER,” and then press the  (ENTER) key to confirm. To cancel the selection, press the  (NEXT) or  (PREV.) key.

Step 4

Press the  (PAUSE) key to cancel PAUSE mode.

3.2 Setting the Interface Conditions

The interface conditions must be set if the RS-232C serial interface is being used. The data transfer rate (baud rate), data length, parity settings, and the handshaking mode for the cutting plotter must be set to match those of the computer operating system. This section describes the cutting-plotter interface conditions. For details on the proper settings for your application or computer operation system, refer to the manual provided with the application or operating system.

Step 1

Check to confirm that the cutting plotter is in READY mode (displaying the current pen settings).



1 PEN 12 30 2

Step 2

Press the **⏸ (PAUSE)** key to switch to PAUSE mode, and then press the **⏪ (NEXT)** or **⏩ (PREV.)** key until the menu shown below is displayed.



RS-232C

Step 3

Press the **⏵ (ENTER)** key to display the interface settings.



▶ 9600 N 8 H

The current settings are displayed (from the left): transfer rate (baud rate), parity, data length, and handshaking mode.

The baud rate can be set to “19200,” “9600,” “4800,” “2400,” “1200,” “600,” or “300.”

The parity can be set to “N” (None), “E” (Even parity), or “O” (Odd parity). The data length can be set to 7 or 8 bits.

The handshaking mode can be set to “H” (hard-wired handshaking) or “X” (Xon/Xoff handshaking). “E” (ENQ/ACK handshaking) can also be selected when the command mode is set to HP-GL.

All of these interface conditions must be set to match the corresponding settings in the application software and the computer operating system.

The parameter that can be changed is displayed immediately to the right of the ▶ mark. Use the **◀** or **▶** key to select the parameter to be changed, and use the **▲** or **▼** key to select the setting details. Press the **⏵ (ENTER)** key to confirm. To cancel the selection, press the **⏪ (NEXT)** or **⏩ (PREV.)** key.

Step 4

Press the **⏸ (PAUSE)** key to cancel PAUSE mode.

3.3 Setting the Cutter-Pen Conditions

Before starting cutting, set the TOOL (cutter blade or pen), cutter-blade length, OFFSET, FORCE, SPEED, and QUALITY settings to ensure the optimal cutting conditions.

- (1) TOOL (cutter blade or pen): Set to suit the material to be cut.
- (2) Cutter-blade length: Adjust the blade length by referring to the media thickness table below. For details on adjusting the blade length, see “2.4 Adjusting and Mounting the Cutter Pen.”
- (3) OFFSET: Set to suit the cutter blade being used.
- (4) FORCE: Set the FORCE by referring to the table below.
- (5) SPEED: Set the SPEED by referring to the table below.
- (6) QUALITY: Set the QUALITY by referring to the table below.

Optimal Cutting Conditions for Each Media Type

| Media type | Thickness (mm) | Blade used | FORCE | SPEED | QUALITY |
|--------------------------------------|----------------|-----------------------------------|----------|------------|---------|
| Film for outdoor use | 0.05 to 0.08 | CB09UA | 10 to 14 | 30 or less | 2 |
| | | CB15UB (for small-letter cutting) | 10 to 14 | 20 or less | 1 |
| Film for decorative use | 0.08 to 0.1 | CB09UA | 14 to 17 | 30 or less | 2 |
| Transparent or semi-transparent film | 0.08 to 0.1 | CB09UA | 14 to 20 | 30 or less | 2 |
| Reflective film | 0.08 to 0.1 | CB09UA | 14 to 20 | 30 or less | 2 |
| Fluorescent film | 0.20 to 0.25 | CB09UA, CB15U | 20 to 21 | 20 or less | 1 |

Blade Part Nos., Displayed Blade Types, and Displayed CUTTER OFFSET Values

| Blade material | Part No. | LCD display indication | | Specifiable range | Initial CUTTER OFFSET |
|-------------------|----------|------------------------|---------|-------------------|-----------------------|
| | | Blade type | Default | | |
| Supersteel blades | CB09UA | 09U | 0 | ±5 | 18 |
| | CB15U | 15U | 0 | ±5 | 28 |
| | CB15UB | 15B | 0 | ±5 | 5 |
| Pens | | Pen | — | — | 0 |

When the TOOL (cutter blade or pen) has been selected from among “09U,” “15U,” and “15B,” the OFFSET is automatically adjusted by ±5 with respect to the default cutter offset value for that blade type. Select the PEN setting for plotting using a pen. When the PEN setting is selected, no OFFSET setting is required.

Reference Pen Conditions for Plotting Pens

| Pen type | FORCE | SPEED | QUALITY |
|---------------------------|----------|-------|---------|
| Water-based fiber-tip pen | 10 to 12 | 30 | 2 |

To preserve the pen life, set the FORCE to the lowest setting, and set the SPEED after checking to confirm that there are no faint lines or other problems during plotting.

CHECKPOINT

- If the SPEED and QUALITY settings are set to high values, the cut/plotted results will have a coarser finish, but the overall cutting/plotting time will be reduced.
 - If the SPEED and QUALITY settings are set to low values, the cut/plotted results will have a finer finish, but the overall cutting/plotting time will be longer.
-







■ Selecting Cutter-Pen-Condition Setting Areas

To set the cutter-pen conditions, first select the setting area (condition number). Switching between these setting areas enables any of up to eight predefined media types to be selected easily.

Selection method

Press the  (COND.) key in READY mode to display the cutter-pen conditions.



To select condition settings that have previously been stored, use the  or  key to select the desired condition number stored on the cutter-pen-condition settings display (the number at the left of the display), and then press the  (ENTER) key. To cancel the selection, press the  (NEXT),  (PREV.), or  (COND.) key.

■ Storing Cutter-Pen-Condition Setting Areas

The cutter-pen conditions can be stored in nine setting areas numbered “1” to “9.”

CHECKPOINT







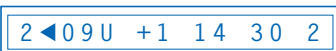





Data from the controller is used for condition number 9.

Storage method

To display the cutter-pen conditions, either press the  (COND.) key when the cutting plotter is in READY mode, or when the media set lever is lowered and the buffer is in the empty (cleared) status.



The current settings are displayed (from the left): condition number, PEN TYPE (cutter blade), CUTTER OFFSET, FORCE, SPEED, and QUALITY.

The item to be changed is indicated by the  symbol. Press the  key to change the symbol to , and press again to move it to the right. Press the  key to move it to the left. Use the  or  key to select the parameter to be changed, and use the  or  key to select the setting details. Press the  (ENTER) key to confirm. To cancel the selection, press the  (NEXT),  (PREV.), or  (COND.) key.

CHECKPOINT

When using the optional registration mark scanner, condition settings 1 and 2 are used for the pen settings when performing “Adjusting the Registration-Mark Reading Sensor (2)” (refer to page 4-18). It is therefore more convenient if the cutter pen settings are assigned to 3 to 8 first.

■ Setting TOOL (cutter blade or pen)

Set the type of pen (cutter blade) to be used.

Step 1

To display the cutter-pen conditions, either press the **(COND.)** key when the cutting plotter is in READY mode, or when the media set lever is lowered and the buffer is in the empty (cleared) status.

Step 2

Select the setting area (condition number) to be set, and then press the **◀** or **▶** key to move the **▶** symbol to the position shown below.

2 ▶ 09U +1 14 30 2

Step 3

Press the **▲** or **▼** key to select "09U," "15U," "15B," or "PEN." Press the **(ENTER)** key to confirm the selection. If other conditions are to be set, press the **◀** or **▶** key to move the **▶** symbol to the parameter to be set.

■ Setting OFFSET

This setting adjusts the offset of the cutter blade to suit the blade type used. The tip of the blade mounted in the cutter-pen plunger is not positioned at the center of the pen, so correction is required. This correction is referred to as the OFFSET setting. The cutting plotter has been preset with OFFSET values for each cutter-blade type. Selecting "09U," "15U," or "15B" for the PEN TYPE setting also sets the appropriate OFFSET, allowing fine adjustment within the range of ± 5 . When the "PEN" setting is selected, the OFFSET cannot be set.

Step 1

Press the **(COND.)** key in READY mode to display the cutter-pen conditions.

Step 2

Select the setting area (condition number) to be set, and then use the **◀** or **▶** key to move the **▶** symbol to the position shown below.

2 09U ▶ +1 14 30 2

Step 3

Use the **▲** or **▼** key to select the value to be changed in the range of "-5" to "+5." Press the **(ENTER)** key to confirm the selection. If other conditions are to be set, press the **◀** or **▶** key to move the **▶** symbol to the parameter to be set.



■ Setting FORCE

Sets the pressure applied by the cutter pen during cutting. Set the FORCE value based on the guidelines in the table entitled “Optimal Cutting Conditions for Each Media Type” on page 3-5.

Step 1



Press the  (COND.) key in READY mode to display the cutter-pen conditions.





Step 2

Select the setting area (condition number) to be set, and then use the  or  key to move the  symbol to the position shown below.

2 09U +1  14 30 2

Step 3

Press the  or  key to select the value to be changed in the range specified below.
“1” to “31”

Press the  (ENTER) key to confirm the selection. If other conditions are to be set, press the  or  key to move the  symbol to the parameter to be set.



■ Setting SPEED

Sets the speed used for cutting. Set the SPEED value based on the guidelines in the table entitled “Optimal Cutting Conditions for Each Media Type” on page 3-5.

Step 1



Press the  (COND.) key in READY mode to display the cutter-pen conditions.

Step 2





Select the setting area (condition number) to be set, and then use the  or  key to move the  symbol to the position shown below.

2 09U +1 14  30 2

Step 3

Press the  or  key to select the value to be corrected in the range specified below.
“1” to “45”

For all cutting plotters, “1” to “10” is in increments of 1, and “10” to “45” is in increments of 5.

Press the  (ENTER) key to confirm the selection. If other conditions are to be set, press the  or  key to move the  symbol to the parameter to be set.



■ Setting QUALITY

Sets the acceleration used in cutting.

Step 1



Press the  (**COND.**) key in READY mode to display the cutter-pen conditions.





Step 2

Select the setting area (condition number) to be set, and then use the  or  key to move the  symbol to the position shown below.

2 09U +1 23 30 

Step 3

Press the  or  key to select the value to be changed in the range specified below
“1”, “2”, “3”











Press the  (**ENTER**) key to confirm the selection. If other conditions are to be set, press the  or  key to move the  symbol to the parameter to be set.

3.4 Displaying the Effective Cutting Area

Press the  (**ENTER**) key in READY mode to display the current effective cutting area.

X 0000mm Y 000mm

3.5 Moving the Pen

In READY mode, press the  or  key to move the pen carriage to the left or right, and the  or  key to feed the medium backward or forward. Pressing the  (**NEXT**), or  (**PREV.**) key together with the     (**POSITION**) keys enables high-speed or low-speed movement.

    (**POSITION**) keys +  (**NEXT**) key: High-speed movement

    (**POSITION**) keys +  (**PREV.**) key: Low-speed movement

3.6 Setting the Initial Cutting Position (Origin Point)

This function allows the starting position for cutting or plotting to be moved to the desired position.

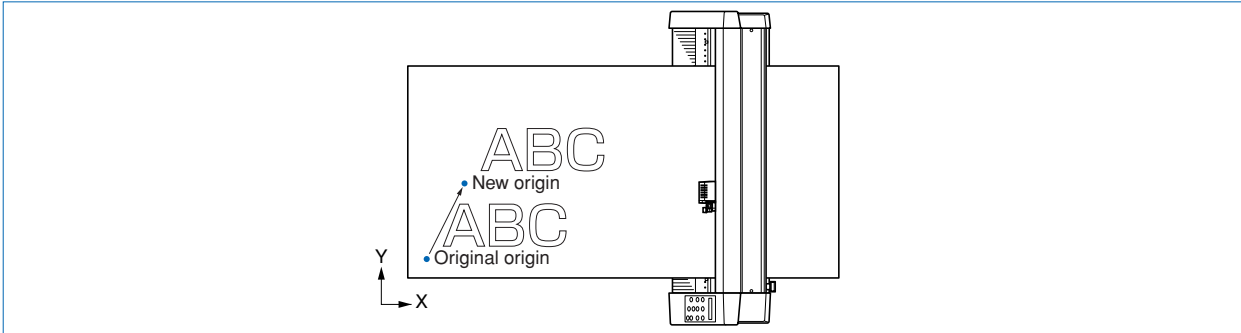

Step 1

In READY mode, use the ◀, ▶, ▲, and ▼ (POSITION) keys to move the cutter pen to the new origin point.

Step 2

Press the ⊕ (ORIGIN) key. The following menu is displayed and the new origin is set.

ORIGIN PT SET

When the Origin is Moved After Rotating the Coordinate Axes

Moving the origin when the coordinate axes have been rotated gives the following results.

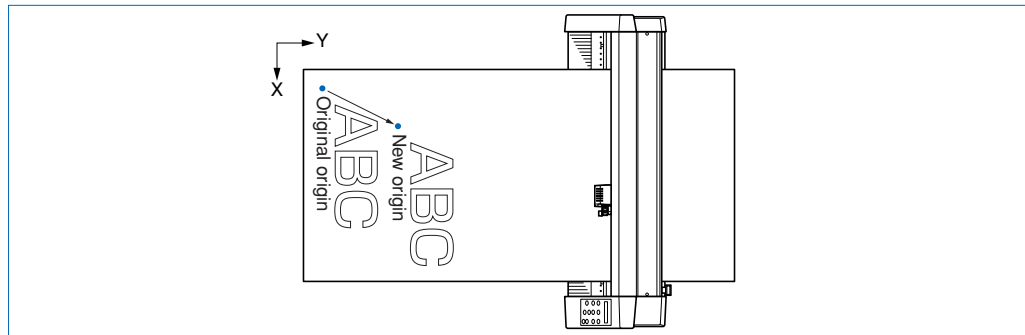

When the Coordinate Axes are Rotated After Moving the Origin Point

When the coordinate axes are rotated after the origin point is moved, the origin point is reset as shown in the figure below. The distance "a" is retained, but the distance "b" is reset.

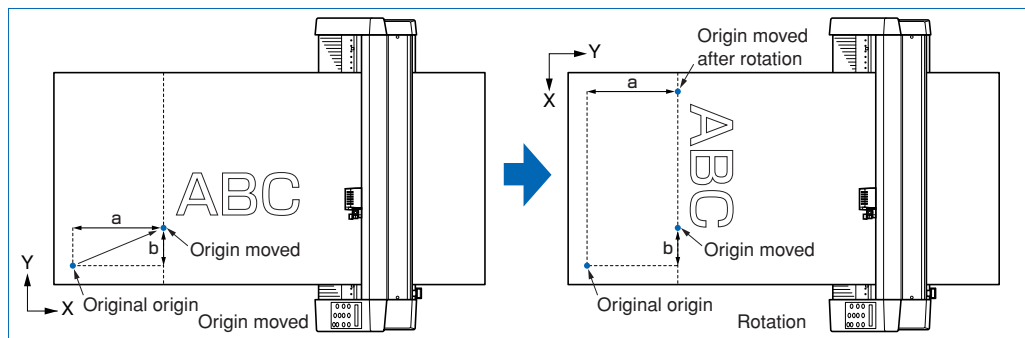

When it is necessary to both move the origin and rotate the coordinate axes, be sure to rotate the coordinate axes first.



After a new origin point is set, the displayed coordinate values of X= and Y= represent the respective distances from the new origin.

3.7 Stop Function

Cutting or plotting can be stopped by pressing the **⏸ (PAUSE) key** while cutting or plotting is in progress. The operation selection menu is displayed on the control-panel screen while cutting or plotting is stopped, enabling operations to be resumed or aborted as required. Raising or lowering the media set lever while the cutting or plotting is stopped does not require the medium to be selected, so the medium can be replaced or reset.

Step 1

Press the **⏸ (PAUSE) key** while cutting or plotting is in progress to stop cutting or plotting and display the PAUSE menu.

CONTINUE JOB

Step 2

Press the **⏪ (NEXT) or ⏩ (PREV.) key** to alternate the display between “CONTINUE JOB” and “QUIT JOB”.

CONTINUE JOB

QUIT JOB

Step 3

Pressing the **↵ (ENTER) key** while “CONTINUE JOB” is displayed cancels the pause function and restarts cutting or plotting.

Step 4

Pressing the **↵ (ENTER) key** while “QUIT JOB” is displayed displays the BUFFER CLEAR confirmation screen for aborting the cutting/plotting operation.

CLEAR <YES>

Step 5

Press the **▲ or ▼ key** to alternate the display between “YES” or “NO”. To abort the cutting/plotting operation, stop the transmission of data from the computer, select “YES”, and then press the **↵ (ENTER) key**. All the cutting/plotting data stored in the buffer is cleared and the plotter returns to Ready status.

To cancel the aborting of the cutting/plotting operation, select “NO” and then press the **↵ (ENTER) key**. The plotter returns to the “CONTINUE JOB” display.

3.8 Moving the Pen Carriage in +100 mm Steps

This function allows the pen carriage to be moved from its current position in +100 mm steps along the X- and Y-axes.

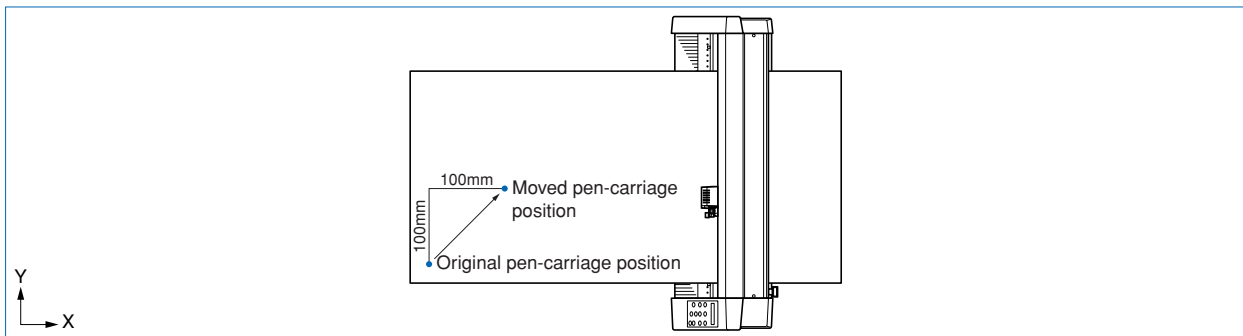

In READY mode, press the **▲** key while holding down the **⏎** (ENTER) key to move the pen carriage in +100 mm steps along the X- and Y-axes.

Returning to the original position

In READY or PAUSE mode, press the **▶** key while holding down the **⏎** (ENTER) key to return the pen carriage to the origin.

3.9 Test Cutting

Test cutting can be performed after selecting the TOOL (cutter blade) and specifying the cutter-blade length, OFFSET, FORCE, SPEED, and QUALITY settings to ensure that the selected cutting conditions actually produce the desired cutting results. Check how far the blade cuts into the film and how corners are being cut; if the cutting results are not satisfactory, reset the cutting conditions and repeat the test cutting until the optimal settings are achieved. If you perform test cutting while the cutter-pen conditions are being set, the test cutting will be performed under the conditions being set.

Step 1

Load the medium for test cutting on the cutting plotter.

Step 2

Use the **◀**, **▶**, **▲**, and **▼** (POSITION) keys to move the pen carriage to the position for test cutting.

Step 3

Switch to READY mode, and then press the **⏎** (TEST) key.

Step 4

When test cutting has been completed, the pen carriage moves to the standby position and the following menu is displayed.

PRESS ENTER KEY

Step 5

Press the **(ENTER)** key to return the pen carriage to its previous position and to switch the cutting plotter to READY mode.

Step 6

Adjust the CUTTER OFFSET value to suit the type and thickness of the medium being used, and fine-adjust the finish of each corner. Set the FORCE so that only faint cutting lines remain on the base sheet when the blade length is properly adjusted.

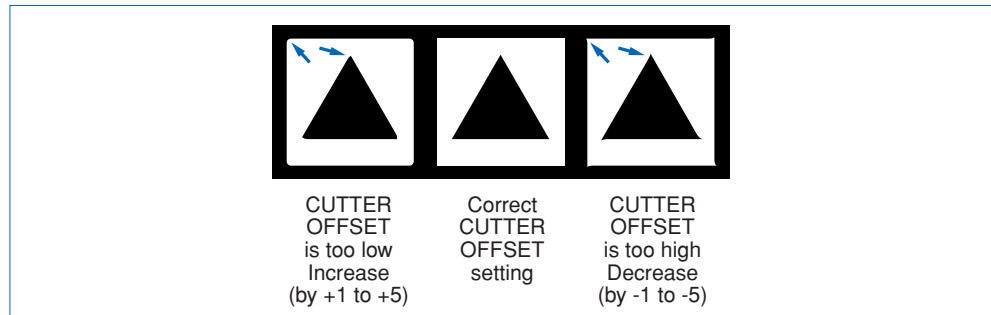

Step 7

Upon completion of fine adjustment, actual cutting data can be sent to the cutting plotter.

4

FUNCTION SETTINGS AND OPERATIONS

| | | |
|------|--|------|
| 4.1 | PAUSE Menu List | 4-2 |
| 4.2 | Reading the Auto Registration Marks (Option)..... | 4-3 |
| 4.3 | Setting the FEED function..... | 4-4 |
| 4.4 | Setting AUTO PRE-FEED | 4-5 |
| 4.5 | Setting TANGENTIAL Mode..... | 4-6 |
| 4.6 | Auto-Registration-Mark-Reading Settings (Option) | 4-8 |
| 4.7 | Clearing the Buffer Memory..... | 4-22 |
| 4.8 | Aligning the Coordinate Axes..... | 4-23 |
| 4.9 | Distance Adjustment..... | 4-25 |
| 4.10 | Setting the PAGE LENGTH..... | 4-27 |
| 4.11 | Setting the Cutting/Plotting Area..... | 4-28 |
| 4.12 | Expanding the Cutting/Plotting Area..... | 4-29 |
| 4.13 | Rotating the Coordinate Axes..... | 4-30 |
| 4.14 | Mirroring | 4-31 |
| 4.15 | Cutting/Plotting Using the Buffer Memory (COPY Function)..... | 4-32 |
| 4.16 | Sorting Settings | 4-34 |
| 4.17 | Interface Settings | 4-35 |
| 4.18 | Setting the Format of Data to be Received | 4-36 |
| 4.19 | Blade Wear Detection (When Blade Wear Setup is On) | 4-38 |
| 4.20 | Raising and Lowering the Pen..... | 4-42 |
| 4.21 | TEST Mode..... | 4-43 |
| 4.22 | Setting the PEN UP SPEED..... | 4-47 |
| 4.23 | Setting the OFFSET FORCE (Initial Cutting Force) | 4-48 |
| 4.24 | Setting the OFFSET ANGLE | 4-49 |
| 4.25 | Setting the STEP PASS..... | 4-50 |
| 4.26 | Setting the Initial Down Force..... | 4-51 |
| 4.27 | Setting the LENGTH UNIT..... | 4-52 |

4.1 PAUSE Menu List

Pressing the **⏸ (PAUSE) key** in READY mode displays the PAUSE menu, enabling the various settings to be made. Select the required menu by scrolling through the list using the **⏪ (NEXT) or ⏩ (PREV.) key**.
 Note: "MOVE TO R. MARK" is applied only for RMS model (Option).
 "AUTO REG. MARK" is applied only for RMS model (Option).

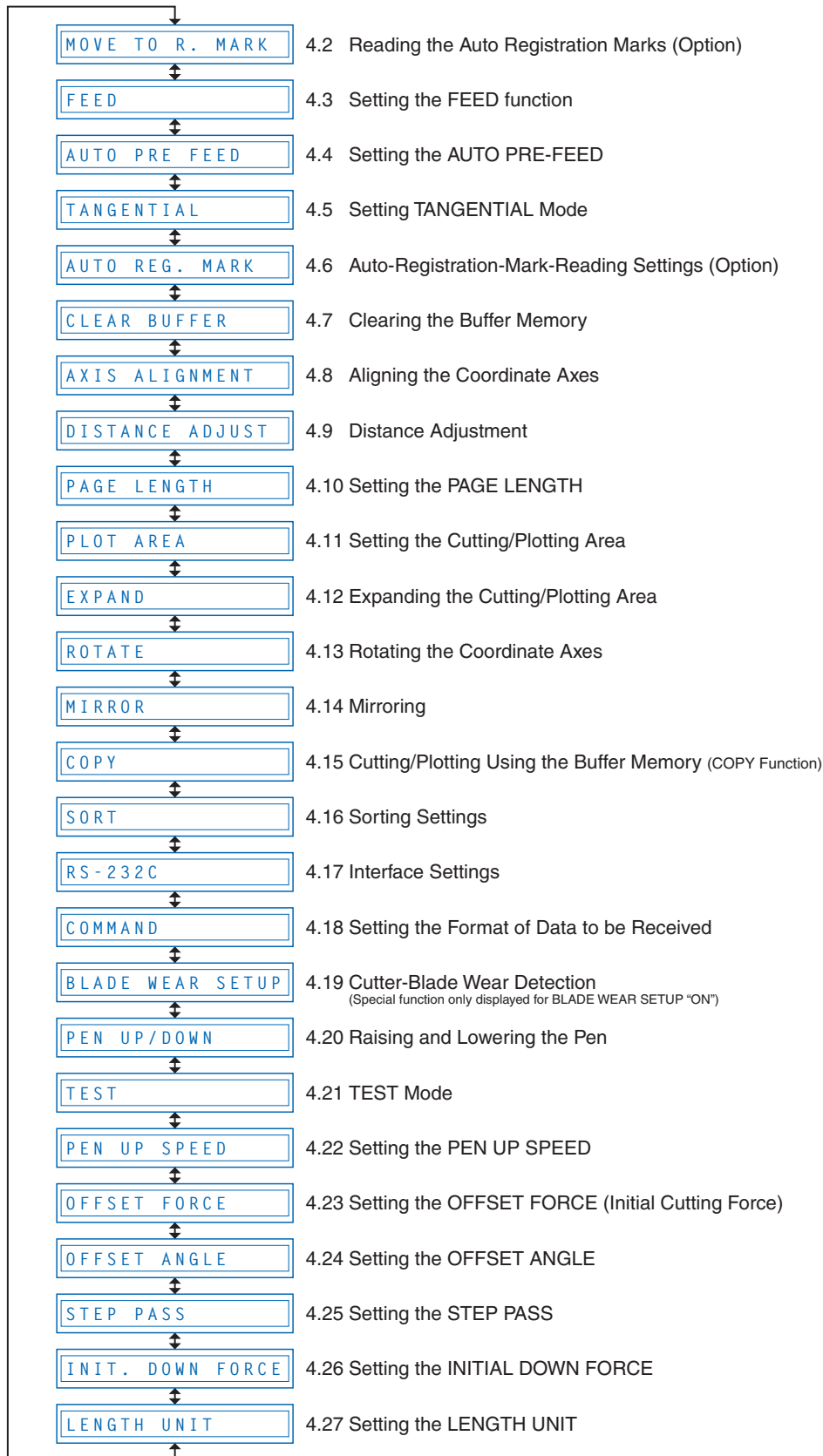

4.2 Reading the Auto Registration Marks (Option)

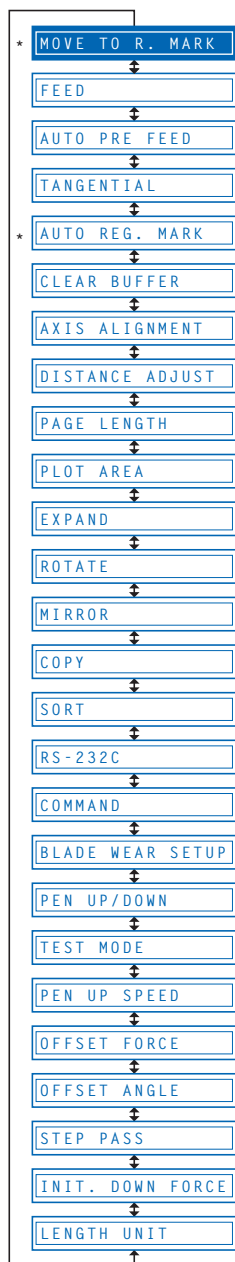

*: Option

Step 1

When “2 POINT,” “3 POINT,” or “4 POINT” has been set (see “4.6 Auto-Registration-Mark-Reading Settings (Option)”), press the **⏸ (PAUSE)** key to switch to PAUSE mode and display the following menu.

MOVE TO R. MARK

Step 2

Use the **⬅**, **➡**, **⬆**, and **⬇** (**POSITION**) keys to move the cutter pen to the lower-right registration mark, and then press the **⏎ (ENTER)** key. The sensor reads between points 1 and 2 (and also between points 1 and 3 for 3-point alignment or 4-point alignment), and the following is displayed.

X00308.9 00308.9

CHECKPOINT

- If the registration-mark distance correction is set to “5 mm,” “10 mm,” “50 mm,” or “STD.” the alignment input screen is not displayed.
- The registration marks are read in accordance with the registration-mark-detection movement distance setting.

Step 3

The distance between X-axis registration marks (points 1 and 2) read by the cutting plotter is displayed on the left. Enter the actual distance on the right. Use the **⬅** or **➡** key to move the cursor to the digit to be entered, use the **⬆** or **⬇** key to increase or decrease the values, and then press the **⏎ (ENTER)** key to confirm. For 3-point alignment or 4-point alignment, the distance between the Y-axis registration marks (points 1 to 3) is also displayed and should be set in the same way. To cancel the selection(s), press the **⏏ (NEXT)** or **⏏ (PREV.)** key.

4.3 Setting the FEED function

The FEED function feeds the medium forward and backward to leave faint tracks of the grit rollers on it and prevent the media from slipping during a cutting or plotting operation.

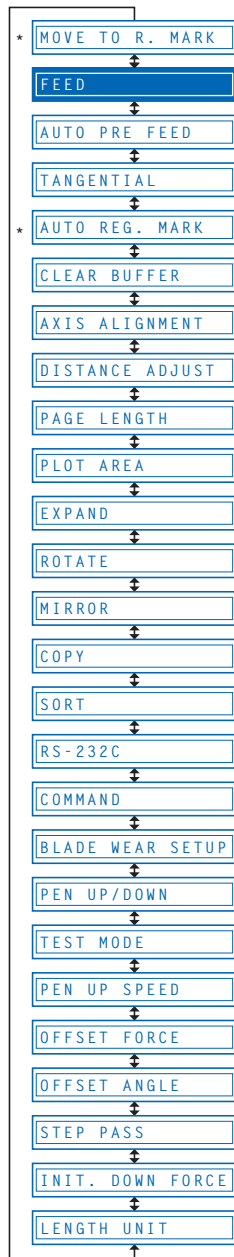

*: Option

Step 1

Press the (PAUSE) key to switch to PAUSE mode.

Step 2

Press the (NEXT) or (PREV.) key until the following menu is displayed.



Step 3

Press the (ENTER) key to display the feed-length setting. Set the length to be fed.



Step 4

Use the or key to set a value within the range of 1 m to 50 m, and then press the (ENTER) key. The cutting plotter performs the feed operation (moves the medium forward and then back to the origin). To cancel the operation, press the (NEXT) or (PREV.) key.

CHECKPOINT

Pressing the (NEXT) or (PREV.) key during the feed operation aborts the feed operation and returns the medium to its original position.

CAUTION

- The feed operation starts immediately once the feed length has been set and the (ENTER) key is pressed. Make sure there are no obstructions at the front or rear of the cutting plotter.
- When using roll media, either extend and load the length to be used beforehand or use the media feed procedure (“4.3 Setting the FEED function”, “4.4 Setting AUTO PRE-FEED”). Beginning cutting or plotting without feeding the media first may generate a position error or may cause the roll media to fall off the stock shaft.

4.4 Setting AUTO PRE-FEED

When the AUTO PRE-FEED function is set to “ON,” the medium is automatically fed forward and backward by the preset length when data is received. This operation leaves traces of the grit rollers on the media and prevents it from slipping during a cutting or plotting operation. Similarly, if roll media is used, the medium is automatically pulled out by the cutting plotter.

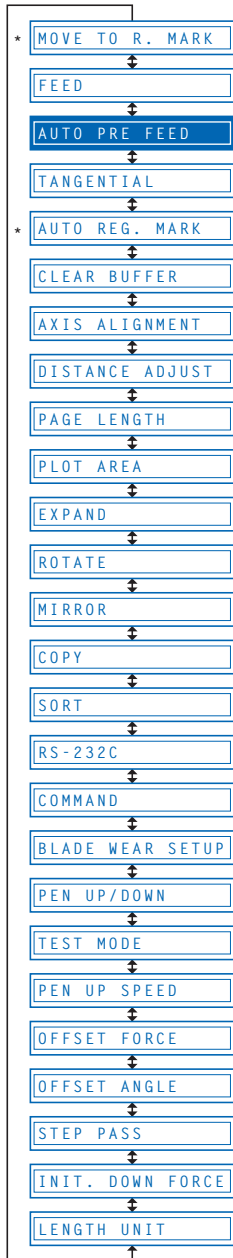

Step 1

Press the **⏸ (PAUSE)** key to switch to PAUSE mode.

Step 2

Press the **⏪ (NEXT)** or **⏩ (PREV.)** key until the following menu is displayed.

AUTO PRE FEED

Step 3

Press the **⏵ (ENTER)** key to display the AUTO PRE-FEED setting.

AUTO PRE FEED ON

Press the **▲** or **▼** key to select “ON” or “OFF,” and then press the **⏵ (ENTER)** key to confirm.

Step 4

If “ON” is selected and the **⏵ (ENTER)** key pressed, the feed-length setting is displayed.

AUTO PRE FEED 1m

Use the **▲** or **▼** key to set a value within the range of 1 m to 50 m, and then press the **⏵ (ENTER)** key to confirm. To cancel the selection, press the **⏪ (NEXT)** or **⏩ (PREV.)** key.

Step 5

Press the **⏸ (PAUSE)** key to cancel PAUSE mode.

⚠ CAUTION When using roll media, either extend and load the length to be used beforehand or use the media feed procedure (“4.3 Setting the FEED function”, “4.4 Setting AUTO PRE-FEED”). Beginning cutting or plotting without feeding the media first may generate a position error or may cause the roll media to fall off the stock shaft.

4.5 Setting TANGENTIAL Mode

This function should be used for the cutting of thick media (more than 0.3 mm in thickness) and when the cutter blade is not able to turn properly due to the cutting depth, resulting in discrepancies between the start and finish point and the inability to cut sharp corners. This function can be set on or off individually for each of the eight cutter-pen setting areas, and it should be set to suit the media used. The overcut-amount setting screen is displayed for cutter-pen setting areas for which the TANGENTIAL mode is “ON.”

This setting has two modes: Mode 1 and Mode 2.

Mode 1: Overcuts the start and finish cutting positions and acute-angle corner sections to avoid leaving uncut sections. In addition, the cutter blade is moved on the surface of the medium during cutting when it is rotated significantly, ensuring sharp cutting unaffected by the medium toughness or thickness.

Mode 2: Overcuts the start and finish cutting positions only. In addition, the cutter is rotated on the medium surface for the start cutting position only. This uses simpler cutter control than Mode 1, and provides a shorter cutting time.

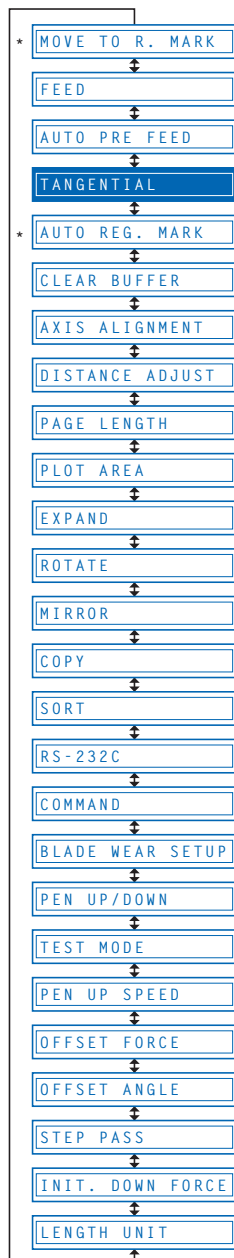

*: Option

Step 1

Press the **⏸ (PAUSE)** key to switch to PAUSE mode.

Step 2

Press the **⏪ (NEXT)** or **⏩ (PREV.)** key until the following menu is displayed.



Step 3

Press the **⏴ (ENTER)** key to display the TANGENTIAL setting. The numbers “1” to “8” indicate the cutter setting areas, and those marked with a **▶** symbol have the TANGENTIAL mode set to “ON.”



Use the **⏪** and **⏩** keys to move the cursor and select a setting area. Use the **⏴** and **⏵** keys to display/not display the **▶** symbol, and then press the **⏴ (ENTER)** key to confirm. To cancel the selection, press the **⏪ (NEXT)** or **⏩ (PREV.)** key

Step 4





Press the **⏸ (PAUSE)** key to cancel PAUSE mode.

Step 5

Select the condition-setting area to be set to “ON” (refer to “Selecting Cutter-Pen-Condition Setting Areas” on page 3-6).



Step 6

Press the  (**ENTER**) key or use the  key to move the cursor to the right-hand side, and then press the  key again to display the menu shown below. If the distance adjustment is set for the setting area selected, the distance adjustment will be displayed here. Either press the  (**ENTER**) key or move the cursor to the right-hand side and press the  key.







TANGENTIAL MODE 1

Step 7

Press the  or  key to select “**Mode 1**” or “**Mode 2**,” and then press the  (**ENTER**) key. The overcut setting is displayed.

STR=0.2 END=0.2

Step 8

“**STR**” indicates the initial overcut amount, and “**END**” indicates the end overcut amount for the line section. Press the  or  key to select “**STR**” or “**END**”, use the  or  key to increase or decrease the values, and then press the  (**ENTER**) key to confirm. To cancel the selection(s), press the  (**NEXT**) or  (**PREV.**) key.

4.6 Auto-Registration-Mark-Reading Settings (Option)

These settings enable pre-plotted media to be cut without any offset by reading the registration marks using the cutting-plotter sensor and adjusting the axes to suit the coordinate data.



Registration-mark reading accuracy *: Within 0.3 mm

* Accuracy when using pens provided with the cutting plotter, high-grade media, and reading the specified pattern.

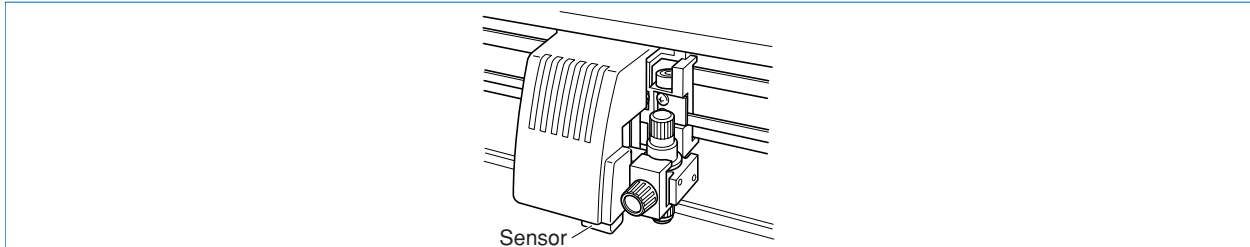

The following precautions must be observed when the registration marks are automatically read.

- Registration-mark pattern
- Reading range required for the detection of registration marks
- Medium and registration-mark position
- Drawing origin point
- Medium type

The registration-mark conditions that can be read by the cutting plotter are as follows.

- Registration-mark line width: 0.3 mm to 1.0 mm (The registration-mark center lines are used as the reference points.)
- Registration-mark size: 5 mm to 20 mm (See “Setting the Registration-Mark Size.”)
- Registration-mark pattern: Pattern 1 or 2 (See “Setting the Registration-Mark Pattern.”)
- Registration marks must be formed of single lines.
- Registration marks must be drawn in black.

The cutting plotter cannot detect registration marks on the following media types.

- Transparent media: The writing surface is also read, preventing the registration-mark lines from being read.
- Non-monochrome drawings: The registration marks cannot be read on colored media or if the registration marks are not black.
- Untidy drawings or media: The registration marks cannot be read if the medium surface is dirty or creased, or if the registration marks are defaced.
- Medium thickness: The registration marks cannot be read if the medium is more than 0.3 mm in thickness.



- The registration marks used in the application software cannot be used. The registration marks must always be created as drawing data.
- If auto mark reading is not possible, use the axis alignment function (see “Setting Axis Alignment”).
- Auto mark reading cannot be performed when MIRROR is set to ON.

Registration-Mark Pattern

The cutting plotter is capable of reading the following registration-mark patterns.

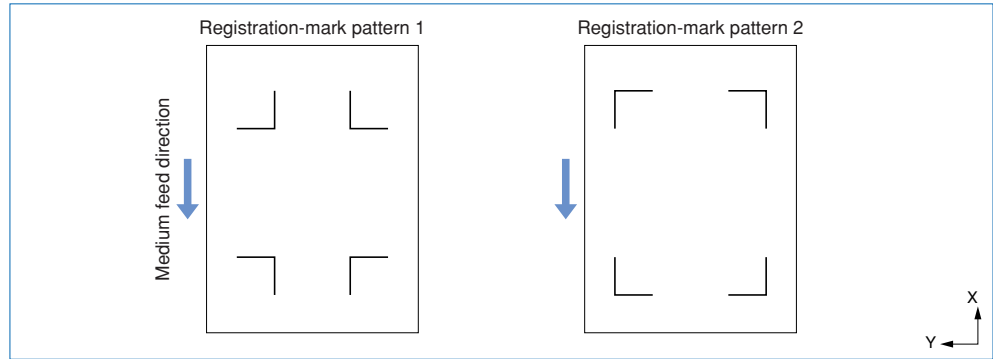

Reading Range Required for the Detection of Registration Marks

The range required for the detection of registration marks is as shown below.

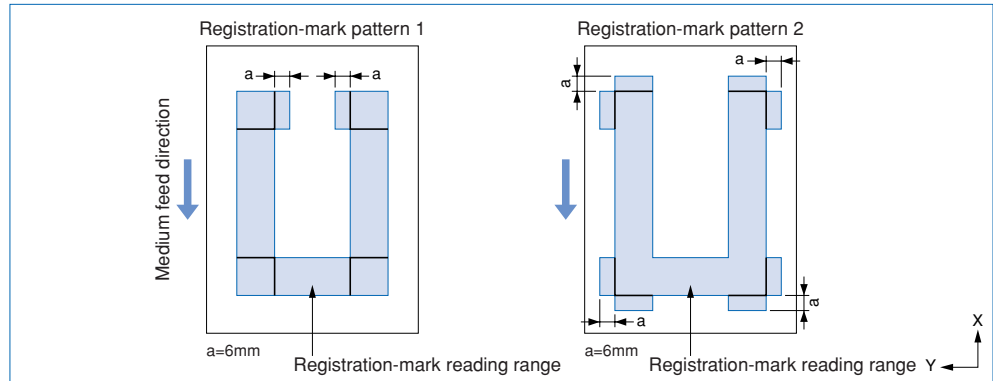

CHECKPOINT

- Incorrect detection may occur if there are marks other than registration marks within the reading range. If drawings overlap the registration-mark reading range, refer to “Setting the Registration-mark detection movement distance.”
- Incorrect detection may occur if the registration-mark reading range is dirty or foreign matter is adhering to the medium surface.

Medium and Registration-Mark Position

Blank margins must be left between the medium edges and the registration marks to enable the marks to be read.

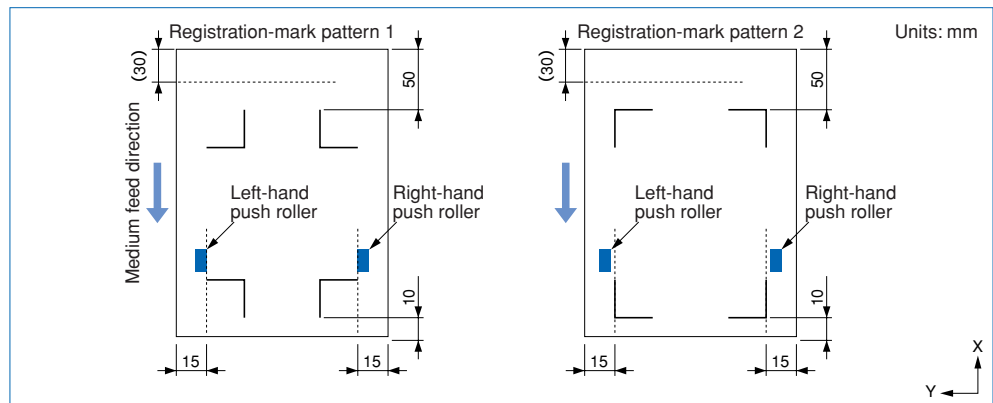

Note: The margins in parentheses are the blank margins that must be left between the medium edges and the cutting area in SHEET mode.

Drawing Origin Point

The drawing origin point following reading of the registration marks will be at the bottom-right registration mark, as shown below.

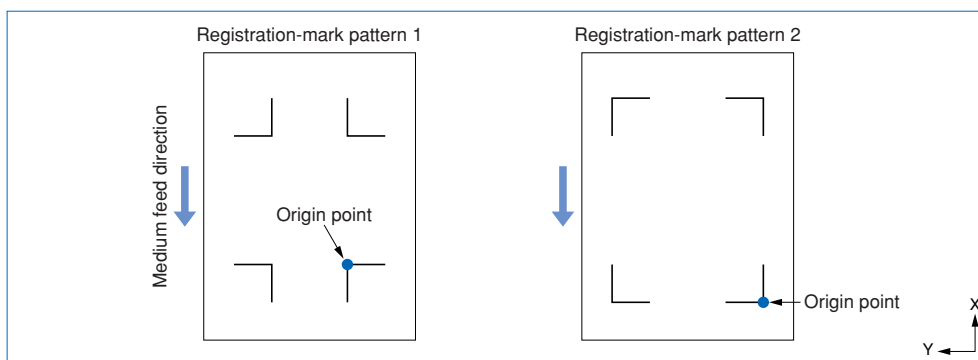

Registration-Mark Menu Tree

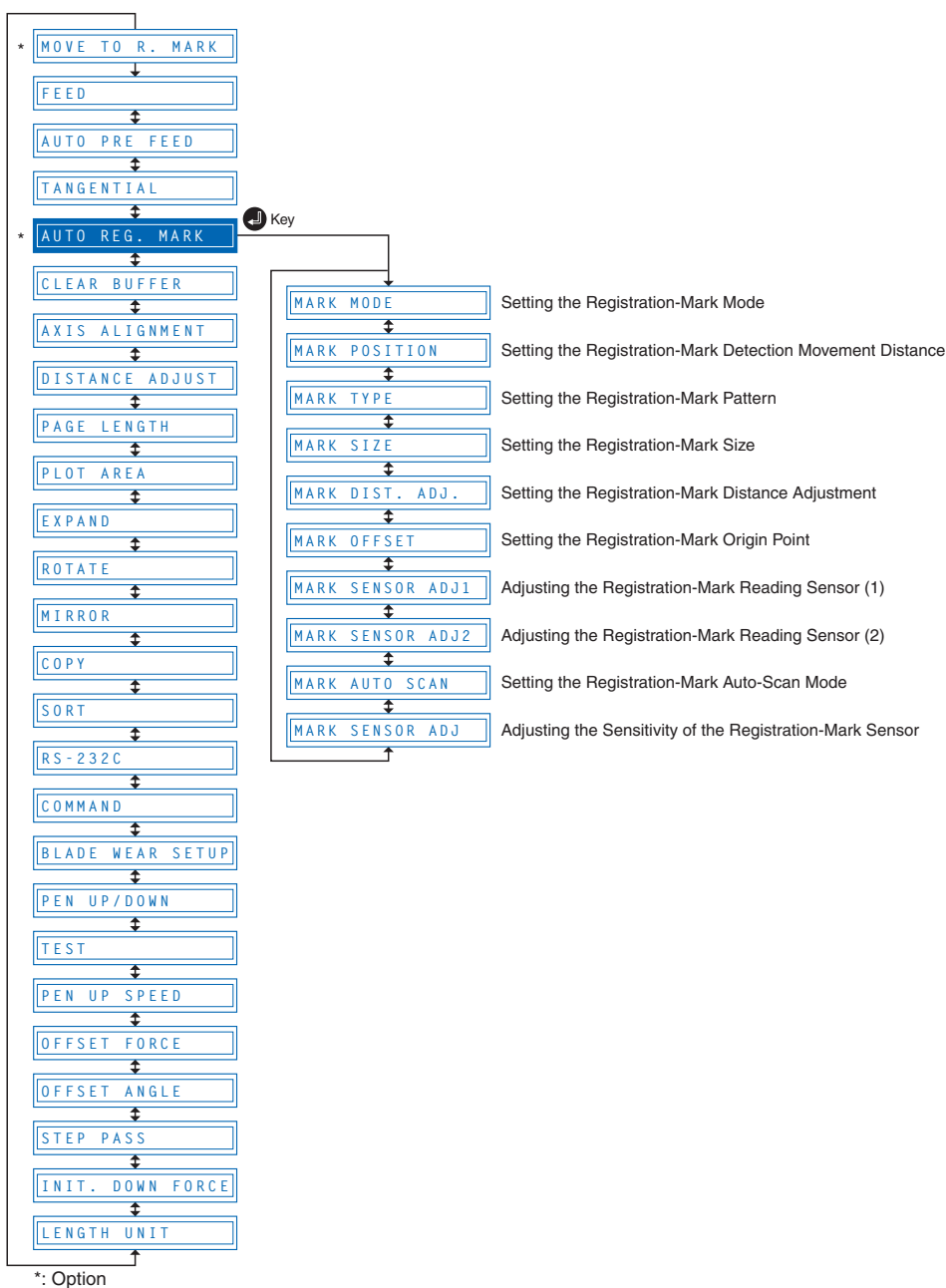

■ Setting the Registration-Mark Mode

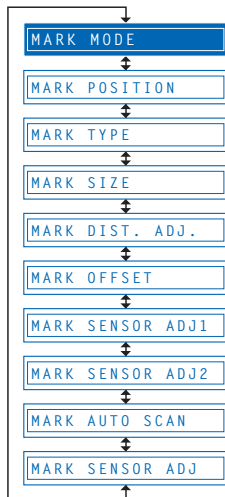

For 2-point alignment, the origin and X-axis registration marks are read; for 3-point alignment, the origin, X-axis, and Y-axis registration marks are read; and for 4-point alignment, all four registration marks are read. Axis alignment (correction of any tilt) and distance adjustment are then performed.

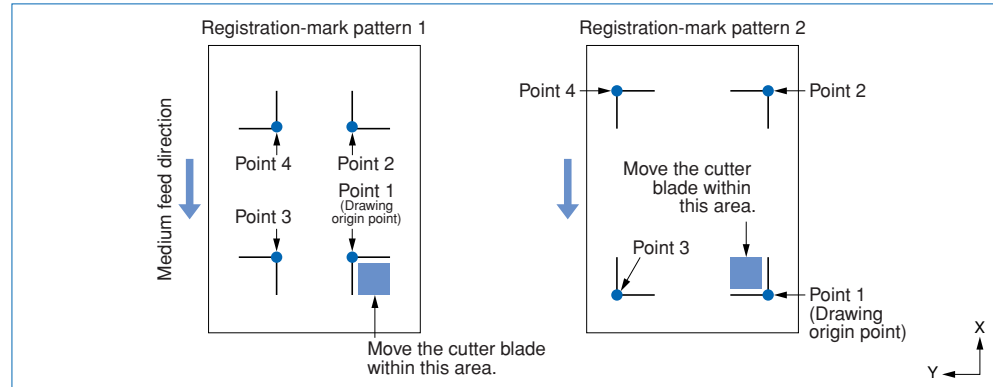

Step 1

Press the **⏸ (PAUSE)** key to switch to PAUSE mode.

Step 2

Press the **⏪ (NEXT)** or **⏩ (PREV.)** key until the following menu is displayed.

AUTO REG. MARK

Step 3

Press the **⏵ (ENTER)** key to display the Auto Reg. Mark submenu.

MARK MODE

Step 4

Press the **⏵ (ENTER)** key to display the MARK mode settings.

MARK MODE OFF

Step 5

Press the **▲** or **▼** key to select “OFF,” “2 POINT,” “3 POINT,” or “4 POINT,” and then press the **⏵ (ENTER)** key to confirm.

Step 6

Press the **⏸ (PAUSE)** key to cancel PAUSE mode.

Setting the Registration-Mark Detection Movement Distance

This sets the distance between the registration marks and changes the initial registration-mark scanning position. Avoiding reading areas that obviously do not include registration marks increases the registration-mark reading speed and minimizes the possibility of incorrect reading due to other marks on the medium

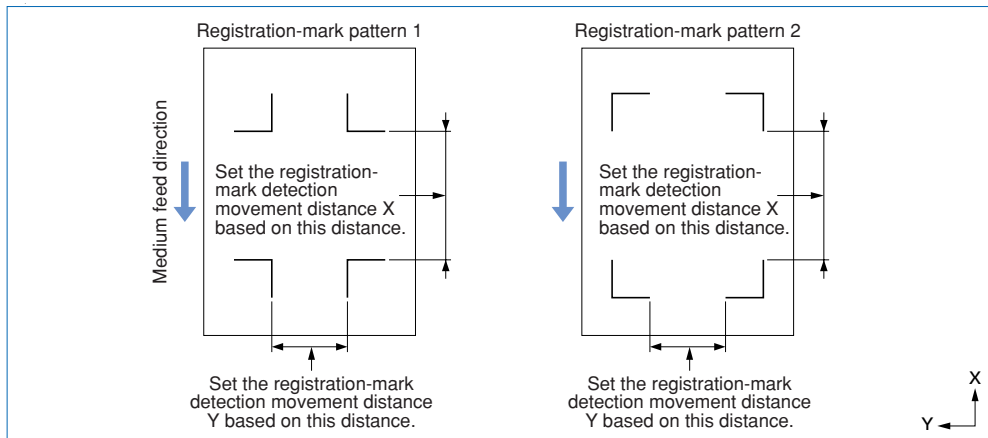
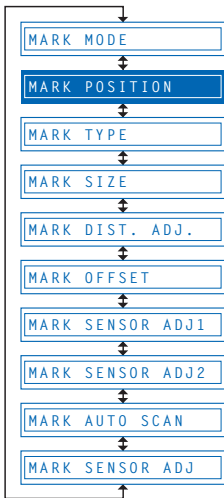

Step 1

Press the **⏸ (PAUSE)** key to switch to PAUSE mode.

Step 2

Press the **⏪ (NEXT)** or **⏩ (PREV.)** key until the following menu is displayed.

AUTO REG. MARK

Step 3

Press the **⏵ (ENTER)** key to display the Auto Reg. Mark submenu, and then press the **⏪ (NEXT)** or **⏩ (PREV.)** key until the following menu is displayed.

MARK POSITION

Step 4

Press the **⏵ (ENTER)** key to display the registration-mark detection movement distance X-axis setting.

M. POS X=0000mm

Step 5

Use the **▲** or **▼** key to move the cursor to the digit to be entered, use the **▲** or **▼** key to increase or decrease the values, and then press the **⏵ (ENTER)** key to confirm. The Y-axis setting is then displayed and should be set in the same way.

Step 6

Press the **⏸ (PAUSE)** key to cancel PAUSE mode.

CHECKPOINT

- This setting is retained in the memory even when the power is turned off.
- If the detection movement distance is set to 0 mm, the sensor continues detecting between the registration marks without skipping until it detects the next mark.
- For 2-point alignment, the Y value is ignored.
- The medium will be ejected if the detection movement distance is set to a value greater than the medium length.

Setting the Registration-Mark Pattern

The cutting plotter is capable of reading the following registration-mark patterns.

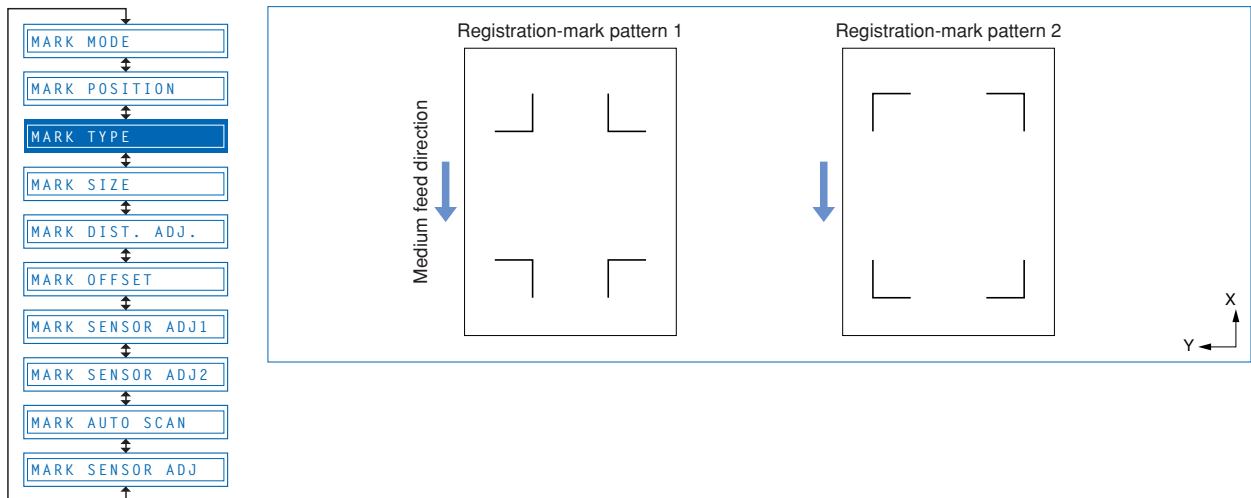

Step 1

Press the **⏸ (PAUSE)** key to switch to PAUSE mode.

Step 2

Press the **⏪ (NEXT)** or **⏩ (PREV.)** key until the following menu is displayed.

AUTO REG. MARK

Step 3

Press the **↵ (ENTER)** key to display the Auto Reg. Mark submenu, and then press the **⏪ (NEXT)** or **⏩ (PREV.)** key until the following menu is displayed.

MARK TYPE

Step 4

Press the **↵ (ENTER)** key to display the registration-mark pattern setting.

MARK TYPE 1

Press the **▲** or **▼** key to select "1" or "2," and then press the **↵ (ENTER)** key to confirm. To cancel the selection, press the **⏪ (NEXT)** or **⏩ (PREV.)** key.

Step 5

Press the **⏸ (PAUSE)** key to cancel PAUSE mode.

CHECKPOINT

The registration-mark conditions that can be read by the cutting plotter are as follows.

- Registration-mark line width: 0.3 mm to 1.0 mm (The registration-mark center lines are used as the data.)
- Registration-mark size: 5 mm to 20 mm (See “Setting the Registration-Mark Size.”)
- Registration-mark pattern: Pattern 1 or 2
- Registration marks must be formed of single lines.
- Registration marks must be drawn in black.

Setting the Registration-Mark Size

This sets the size of the registration marks to be read.

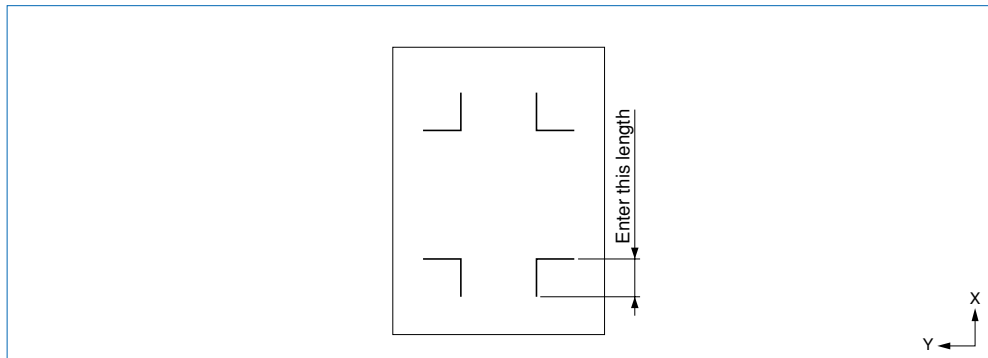
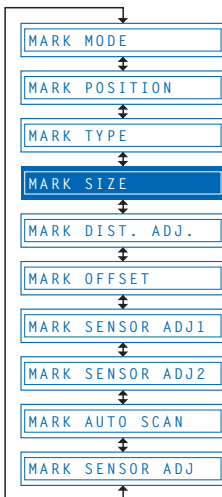

Step 1

Press the **⏸ (PAUSE)** key to switch to PAUSE mode.

Step 2

Press the **⏪ (NEXT)** or **⏩ (PREV.)** key until the following menu is displayed.

AUTO REG. MARK

Step 3

Press the **↵ (ENTER)** key to display the Auto Reg. Mark submenu, and then press the **⏪ (NEXT)** or **⏩ (PREV.)** key until the following menu is displayed.

MARK SIZE

Step 4

Press the **↵ (ENTER)** key to display the registration-mark size setting.

MARK SIZE 10mm

Step 5

Use the ▲ or ▼ key to set the value within the range “5 mm” to “20 mm,” and then press the ↵ (ENTER) key to confirm. To cancel the selection, press the ⏪ (NEXT) or ⏩ (PREV.) key.

Step 6

Press the ⏸ (PAUSE) key to cancel PAUSE mode.

Setting the Registration-Mark Distance Adjustment

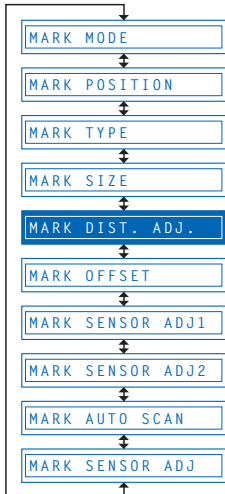

This adjusts the distance between registration marks automatically, rounding up or down to the nearest 5 mm, 10 mm, or 50 mm as specified. If STD. (Standard) is selected, the distance is automatically rounded up or down to the nearest 5 mm, 10 mm, or 50 mm depending on the distance between the marks.

Up to 50 cm: 5 mm; 50 cm to 1 m: 10 mm; 1 m or larger: 50 mm. (Inch display: rounded up or down to the nearest 0.25", 0.5", 0.75", 1", or 1.5").

For example, if the distance adjustment is set to 5 mm and the distance between the registration marks is read as 312 mm, the distance is rounded down to the nearest 5 mm and is treated as a distance of 310 mm.

Step 1

Press the ⏸ (PAUSE) key to switch to PAUSE mode.

Step 2

Press the ⏪ (NEXT) or ⏩ (PREV.) key until the following menu is displayed.

AUTO REG. MARK

Step 3

Press the ↵ (ENTER) key to display the Auto Reg. Mark submenu, and then press the ⏪ (NEXT) or ⏩ (PREV.) key until the following menu is displayed.

MARK DIST. ADJ.

Step 4

Press the ↵ (ENTER) key to display the registration-mark distance-adjustment setting.

MARK DIST. OFF

Step 5

Press the ▲ or ▼ key to select “OFF,” “5 mm,” “10 mm,” “50 mm,” or “STD.” and then press the ↵ (ENTER) key to confirm. To cancel the selection, press the ⏪ (NEXT) or ⏩ (PREV.) key.

If “inch” is the unit displayed, select from among “OFF,” “0.25,” “0.5,” “0.75,” “1.0,” “1.5” and “STD.”

Step 6

Press the **⏸ (PAUSE)** key to cancel PAUSE mode.

Setting the Registration-Mark Origin Point

If the registration-mark origin point is not set, it will be positioned as shown in the figures below. This function should be set when it is required to move the origin point from this position.

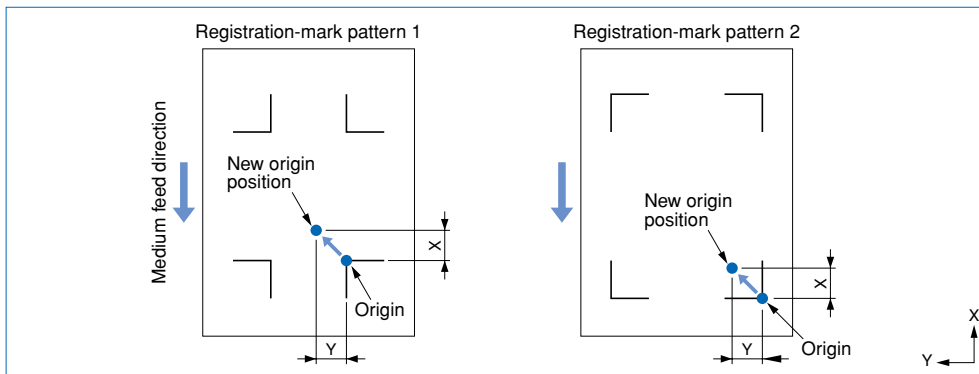
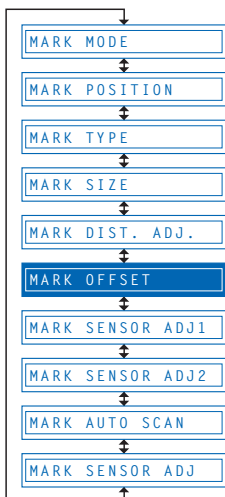

Step 1

Press the **⏸ (PAUSE)** key to switch to PAUSE mode.

Step 2

Press the **⏪ (NEXT)** or **⏩ (PREV.)** key until the following menu is displayed.



Step 3

Press the **⏵ (ENTER)** key to display the Auto Reg. Mark submenu, and then press the **⏪ (NEXT)** or **⏩ (PREV.)** key until the following menu is displayed.



Step 4

Press the **⏵ (ENTER)** key to display the X-axis registration-mark origin input setting.

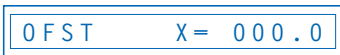

Step 5

Use the **⏪** or **⏩** key to move the cursor to the digit to be entered, use the **⏴** or **⏵** key to increase or decrease the values (or display/don't display “-” for the space to the right of “=”), and then press the **⏵ (ENTER)** key to confirm. The Y-axis origin input setting is then displayed and should be set in the same way. To cancel the selection(s), press the **⏪ (NEXT)** or **⏩ (PREV.)** key.

Step 6

Press the **⏸ (PAUSE)** key to cancel PAUSE mode.

Adjusting the Registration-Mark Reading Sensor (1)

This adjusts the position of the sensor for the reading of registration marks. The adjustment crosshairs are plotted after crosshairs already plotted have been read, and the difference between the two is input to adjust the position.

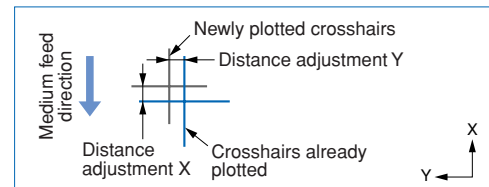
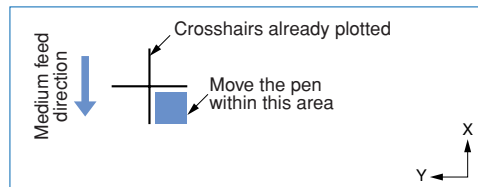
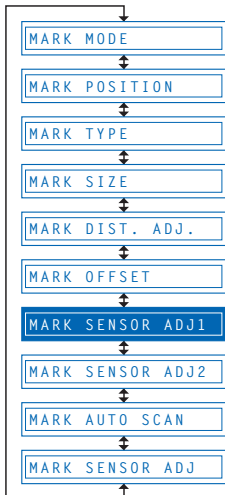

Step 1

Load a medium with the crosshairs plotted.

Step 2

Set the cutter pen conditions to “PEN” (refer to “3.3 Setting the Cutter-Pen Conditions”), and mount a pen in the cutting plotter.

Step 3

Press the **⏸ (PAUSE)** key to switch to PAUSE mode.

Step 4

Press the **⏪ (NEXT)** or **⏩ (PREV.)** key until the following menu is displayed.

AUTO REG. MARK

Step 5

Press the **↵ (ENTER)** key to display the Auto Reg. Mark submenu, and then press the **⏪ (NEXT)** or **⏩ (PREV.)** key until the following menu is displayed.

MARK SENSOR ADJ1

Step 6

Press the **↵ (ENTER)** key. The following menu is displayed.

MARK ADJ1 SCAN

Step 7

Use the **⬅**, **➡**, **⬆**, and **⬇** (**POSITION**) keys to move the cutter pen to the position of the crosshairs already plotted on the medium, and then press the **↵ (ENTER)** key. The sensor scans the crosshairs and overwrites them.

Step 8

Measure the offset of the crosshairs in the X-axis, and enter the distance adjustment. Using the already plotted crosshairs as the point of reference, enter the actual amount of the offset between these crosshairs and the crosshairs that were plotted on top of them after the already plotted crosshairs were read by the sensor. (For example, for the figure at the above right, since there is an offset in both the $-X$ and $-Y$ directions, enter the $[X= -**mm]$ and $[Y= -**mm]$ corrective values.)

ADJ X= 0.0

Step 9

Move the cursor to the digit to be entered using the ◀ or ▶ key, use the ▲ or ▼ key to increase or decrease the values (or display/don't display "-" for the space to the right of "="), and then press the ↵ (ENTER) key to confirm. If there is no offset, simply press the ↵ (ENTER) key. The Y-axis distance-adjustment input is then displayed and should be set in the same way. To cancel, press the ⏏ (NEXT) or ⏪ (PREV.) key.

Step 10

Press the ⏏ (PAUSE) key to cancel PAUSE mode.

Adjusting the Registration-Mark Reading Sensor (2)

This adjusts the position of the sensor for reading the registration marks by plotting crosshairs and then reading them. First set both cutter pen conditions 1 and 2 to the same pen. Crosshairs are first plotted using conditions 1 and read by the sensor. A second set of adjustment crosshairs is plotted using conditions 2. The difference between the two is input to adjust the position.

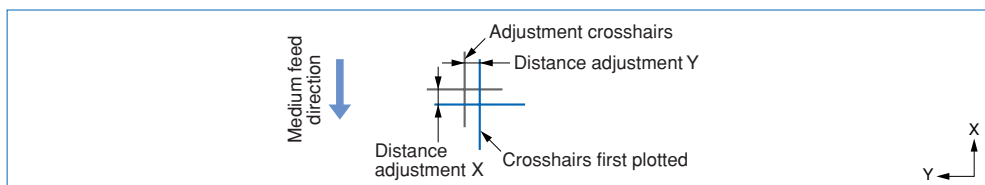
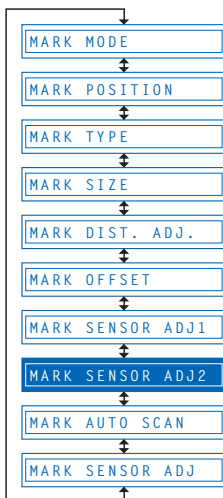

Step 1

Load a medium into the cutting plotter.

Step 2

Set both cutter pen conditions 1 and 2 to the same "Pen" (refer to "3.3 Setting the Cutter-Pen Conditions"), and load a pen in the cutting plotter.

Step 3



Press the ⏏ (PAUSE) key to switch to PAUSE mode.

Step 4

Press the ⏏ (NEXT) or ⏪ (PREV.) key until the following menu is displayed.

AUTO REG. MARK

Step 5

Press the  (**ENTER**) key to display the Auto Reg. Mark submenu, and then press the  (**NEXT**) or  (**PREV.**) key until the following menu is displayed.





MARK SENSOR ADJ2

Step 6

Press the  (**ENTER**) key. The following menu is displayed.

MARK ADJ2 SCAN

Step 7

Use the , , , and  (**POSITION**) keys to move the cutter pen to the position for plotting of the crosshairs, and then press the  (**ENTER**) key. The crosshairs are plotted and the following is displayed.

PRESS ENTER KEY

Step 8









Press the  (**ENTER**) key. The sensor scans the crosshairs and overwrites them.

Step 9

Measure the offset of the crosshairs in the X-axis, and enter the distance adjustment. Using the crosshairs that were plotted first as the point of reference, enter the actual amount of the offset between these crosshairs and the adjustment crosshairs that were plotted after the first crosshairs were read by the sensor. (For example, for the figure shown above, since there is an offset in both the $-X$ and $-Y$ directions, enter the $[X = -**\text{mm}]$ and $[Y = -**\text{mm}]$ corrective values.)

ADJ X = 0.0

Step 10

Use the  or  key to move the cursor to the digit to be entered, use the  or  key to increase or decrease the values (or display/don't display "-" for the space to the right of "="), and then press the  (**ENTER**) key to confirm. If there is no offset, simply press the  (**ENTER**) key. The Y-axis distance-adjustment input is then displayed and should be set in the same way. To cancel the selection(s), press the  (**NEXT**) or  (**PREV.**) key.

Step 11

Press the  (**PAUSE**) key to cancel PAUSE mode.

Setting the Registration-Mark Auto-Scan Mode

If the registration marks are at pre-determined positions on the medium, they can be scanned automatically.

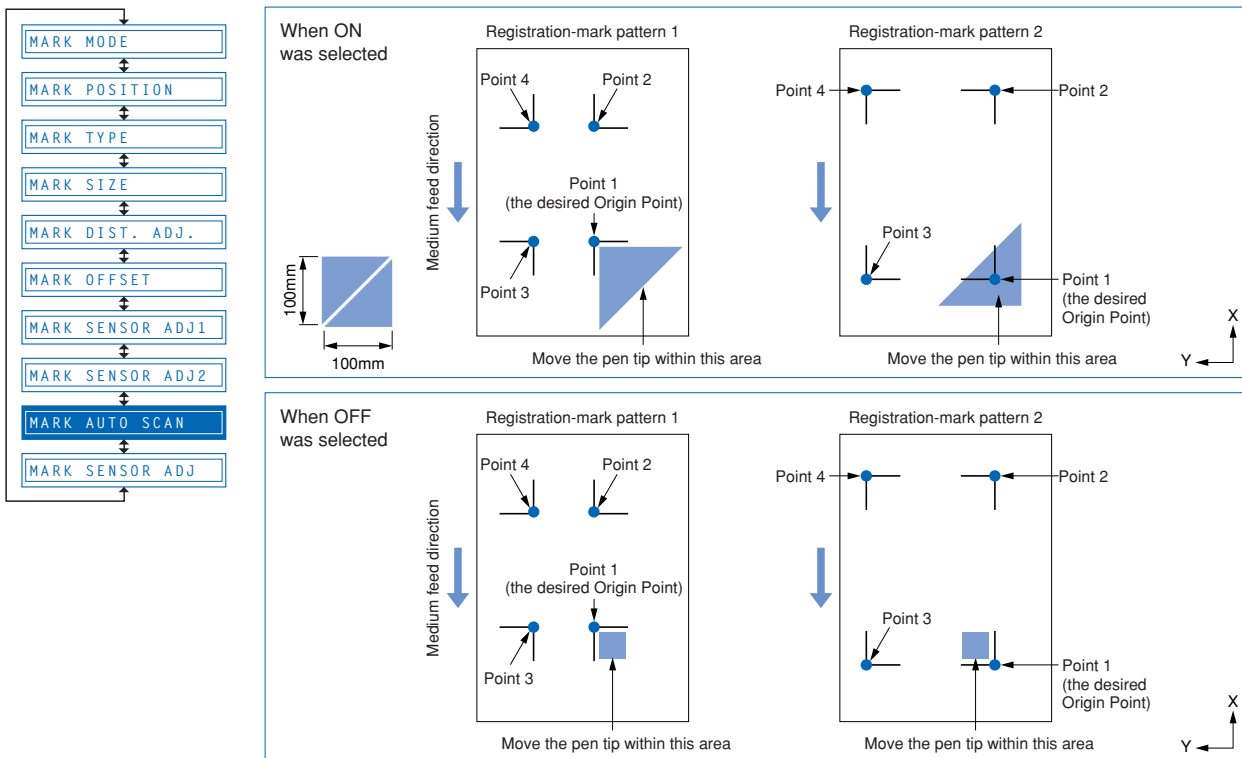

Step 1

Press the **⏸ (PAUSE)** key to switch to PAUSE mode.

Step 2

Press the **⏪ (NEXT)** or **⏩ (PREV.)** key until the following menu is displayed.

AUTO REG. MARK

Step 3

Press the **⏵ (ENTER)** key to display the Auto Reg. Mark submenu, and then press the **⏪ (NEXT)** or **⏩ (PREV.)** key until the following menu is displayed.

MARK AUTO SCAN

Step 4

Press the **⏵ (ENTER)** key to display the Auto-scan mode setting.

AUTO SCAN ON

Step 5

Press the **▲** or **▼** key to select "ON" or "OFF," and then press the **⏵ (ENTER)** key to confirm. To cancel the selection, press the **⏪ (NEXT)** or **⏩ (PREV.)** key.

Step 6

Press the **⏸ (PAUSE)** key to cancel PAUSE mode.

Adjusting the Sensitivity of the Registration-Mark Sensor

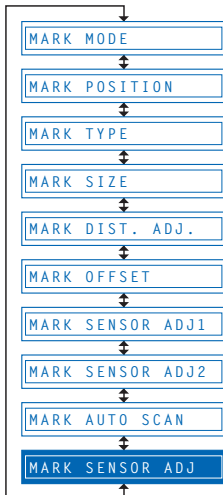

There may be instances when the registration-mark sensor does not function correctly, depending on how it is moved. If this happens, adjusting the sensitivity will enable the sensor to perform detection correctly in most cases.

Step 1

Press the **⏸ (PAUSE)** key to switch to PAUSE mode.

Step 2

Press the **⏪ (NEXT)** or **⏩ (PREV.)** key until the following menu is displayed.

AUTO REG. MARK

Step 3

Press the **↵ (ENTER)** key to display the Auto Reg. Mark submenu, and then press the **⏪ (NEXT)** or **⏩ (PREV.)** key until the following menu is displayed.

MARK SENSOR ADJ

Step 4

Press the **↵ (ENTER)** key to display the Mark Sensor sensitivity setting.

MARK SENSOR 0

Step 5

Use the **▲** or **▼** key to increase or decrease the setting within the range of “-5” to “5,” and then press the **↵ (ENTER)** key to confirm. A positive value increases the sensitivity, but makes the cutting plotter more susceptible to other influences and less able to withstand noise. A negative value decreases the sensitivity, but makes the cutting plotter less susceptible to other influences and more able to withstand noise. To cancel the selection, press the **⏪ (NEXT)** or **⏩ (PREV.)** key.

Step 6

Press the **⏸ (PAUSE)** key to cancel PAUSE mode.

4.7 Clearing the Buffer Memory

This function deletes the data sent to the cutting plotter. It is used to abort cutting while it is in progress.

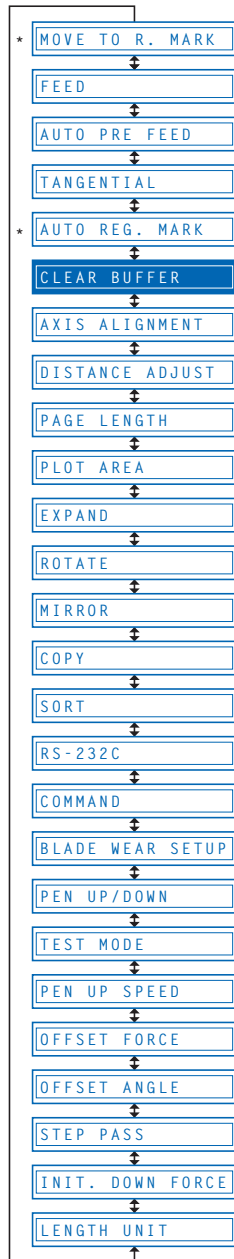

*: Option

Step 1

Press the **⏸ (PAUSE)** key to switch to PAUSE mode.

Step 2

Stop the transmission of data from the computer if this is in progress.

Step 3

Press the **⏪ (NEXT)** or **⏩ (PREV.)** key until the following menu is displayed.

CLEAR BUFFER

Step 4

Press the **⏴ (ENTER)** key to display the clear-buffer-memory menu.

CLEAR <YES>

Step 5

Press the **⬆** or **⬇** key to select “YES” or “NO,” and then press the **⏴ (ENTER)** key. To cancel the selection, select “NO” and press the **⏴ (ENTER)** key, or press the **⏪ (NEXT)** or **⏩ (PREV.)** key.

4.8 Aligning the Coordinate Axes

This function is used to compensate for any offset in the origin or angular deviation in the coordinate axes that occurs when a medium plotted in another plotter is loaded or when a previously plotted medium is reloaded. This function enables the cutting of outlines plotted using a different plotter, or drawings previously plotted to be recut. Plotting the origin and X-axis line before the coordinate axes are aligned makes it easier to adjust the axes. Plot the origin and X-axis line within the plotting area to enable settings to be specified even if the X-axis and origin are positioned at an angle. If the origin and X-axis line are plotted near the boundaries of the plotting area, the settings may lie outside the plotting area, making it impossible to align the axes.

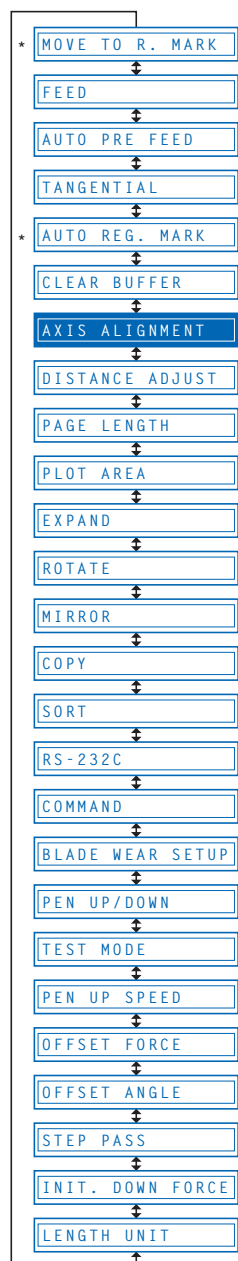

*: Option

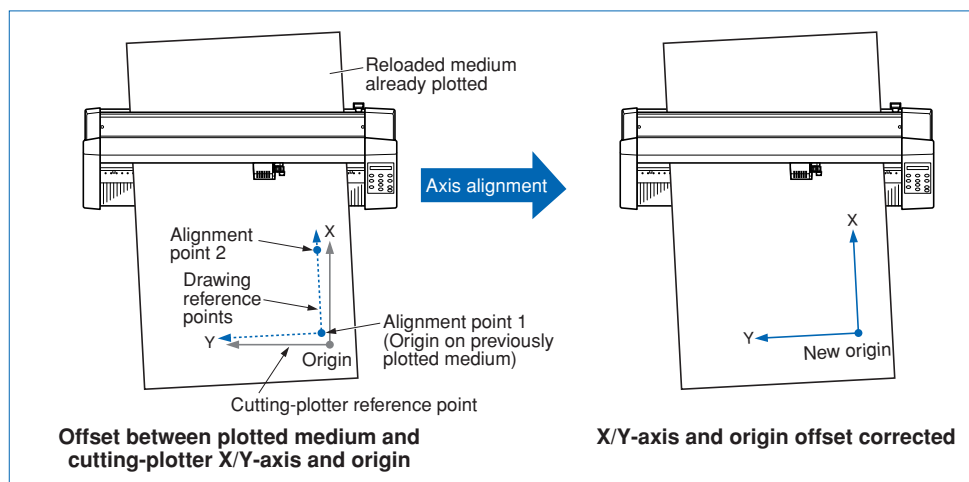

Step 1

Press the **⏸ (PAUSE)** key to switch to PAUSE mode.

Step 2

Press the **⏪ (NEXT)** or **⏩ (PREV.)** key until the following menu is displayed.

AXIS ALIGNMENT

Step 3

Press the **⏏ (ENTER)** key to display the axis-alignment menu.

PT1 0, 0

Use the **⬅, ➡, ▲, and ▼ (POSITION)** keys to move the cutter pen to alignment point 1 (the origin on the previously plotted medium). The coordinates displayed here indicate the distance from the current origin point.

Step 4

Press the **⏏ (ENTER)** key to set the new origin, and use this as the center of rotation for the X-axis.

Step 5

Use the ◀, ▶, ▲, and ▼ (**POSITION**) keys to move the cutter pen to alignment point 2 (any point on the X-axis for the previously plotted medium). The coordinates displayed here indicate the distance from alignment point 1.

| | | |
|------|----|---|
| PT 2 | 0, | 0 |
|------|----|---|

Step 6

Press the ↵ (**ENTER**) key to calculate the X-axis angle of inclination and align the axes.

Step 7

Press the ⏸ (**PAUSE**) key to cancel PAUSE mode.

CHECKPOINT

After the axes are aligned, the settings will be reset if any of the following are performed.

- Specification of a new origin
 - Loading of a new medium
 - Setting of the axis rotation
-

4.9 Distance Adjustment

This function corrects any deviation in the length of cut or the plotted line segments, which occurs depending on the medium being used. The adjustment value for the deviation is specified as a percentage of the total distance. For example, a setting of 0.05% adjusts a distance of 2 m (2,000 mm) by +1 mm (2000 x 0.05% = 1 mm), to become 2,001 mm. Eight different cutter-pen condition-setting areas can be set on or off separately, allowing different settings to be made in order to suit the medium used.

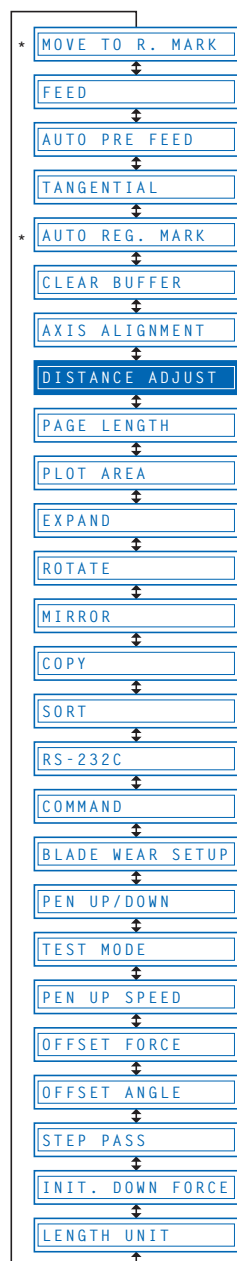

*: Option

Step 1

Press the **⏸ (PAUSE) key** to switch to PAUSE mode.

Step 2

Press the **⏪ (NEXT) or ⏩ (PREV.) key** until the following menu is displayed.



Step 3

Press the **⏴ (ENTER) key** to display the distance adjustment menu. The numbers “1” to “8” indicate the cutter-pen condition-setting areas, and those that are set on are indicated with the **▶** symbol to the left.



Use the **⏪ or ⏩ key** to move the cursor to select the required condition-setting area. Press the **⏴ or ⏵ key** to display or not display the **▶** symbol, and then press the **⏴ (ENTER) key** to confirm. To cancel, press the **⏪ (NEXT) or ⏩ (PREV.) key**.

Step 4

Press the **⏸ (PAUSE) key** to cancel PAUSE mode.

Step 5

Select the condition-setting area to be set to “ON” (refer to “Selecting Cutter-Pen-Condition Setting Areas” on page 3-6).



Step 6

Either press the **⏴ (ENTER) key** or use the **⏩ key** to move the cursor to the far right, and then press the **⏩ key** to display the following menu.

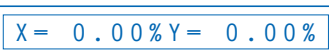

Step 7

Select “X” or “Y” using the ◀ or ▶ key. Use the ▲ or ▼ key to increase or decrease the setting within the range of “-2.00%” to “+2.00%,” and then press the ↵ (ENTER) key to confirm. If the condition-setting area is set for TANGENTIAL mode, the TANGENTIAL-mode setting will be displayed. Press ↵ (ENTER) again. To cancel the selection(s), press the ⏪ (NEXT) or ⏩ (PREV.) key.



This setting is retained in the memory even when the power is turned off.

4.10 Setting the PAGE LENGTH

This function sets the length of each page when long-axis cutting or plotting is performed using a roll medium. This should be set for long-axis cutting or plotting exceeding 5 m in length. The default setting is “5000 mm.”

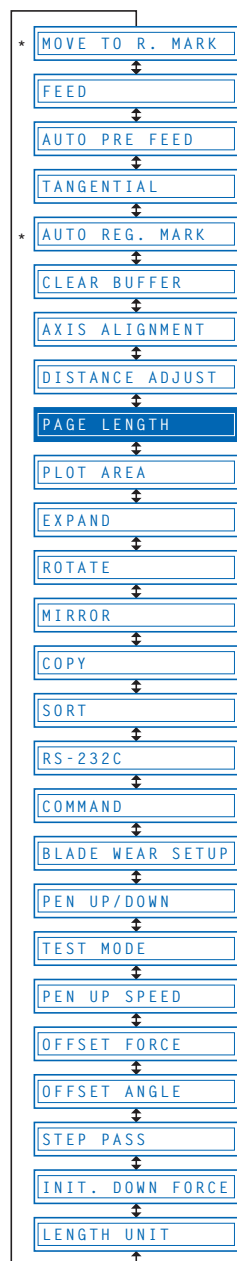

*: Option

Step 1

Press the **⏸ (PAUSE)** key to switch to PAUSE mode.

Step 2

Press the **⏪ (NEXT)** or **⏩ (PREV.)** key until the following menu is displayed.



Step 3

Press the **⏵ (ENTER)** key to display the page-length menu.



Use the **⏪** or **⏩** key to move the cursor to the digit to be changed. Use the **⏴** and **⏵** keys to increase or decrease the setting, and then press the **⏵ (ENTER)** key to confirm. To cancel, press the **⏪ (NEXT)** or **⏩ (PREV.)** key.

Step 4

Press the **⏸ (PAUSE)** key to cancel PAUSE mode.

CHECKPOINT

- This setting is retained in the memory even when the power is turned off.
- The cutting plotter's distance precision is guaranteed for page-feed lengths of up to 5 meters, provided that the following conditions are satisfied. Long-axis cutting over 5 meters is possible for lengths of up to 50 meters in the feeding direction.

Guaranteed precision conditions:

- The cutting plotter is mounted on its stand.
 - Graphtec-specified film is used with the stipulated setting conditions.
- Film: 3M plastic-backed film
Setting conditions: Cutter speed, 30 cm/s max; Quality, 2

CAUTION

- In the case of long-axis cutting, be particularly careful when loading color adhesive-backed film. If the film is loaded at even a slight angle, the film may come loose from the rollers that hold it in place.
- When using roll media, either extend and load the length to be used beforehand or use the media feed procedure (“4.3 Setting the FEED function”, “4.4 Setting AUTO PRE-FEED”).

Beginning cutting or plotting without feeding the media first may generate a position error or may cause the roll media to fall off the stock shaft.

4.11 Setting the Cutting/Plotting Area

This function allows the area in which cutting/plotting will be performed to be specified, thereby preventing cutting/plotting outside the specified area. This function enables more efficient use of the film through the specification of uncut portions of a film that have already been cut, to avoid the previously cut areas. Note that setting of the cutting/plotting area also repositions the origin point in accordance with the movement of the cutting area.

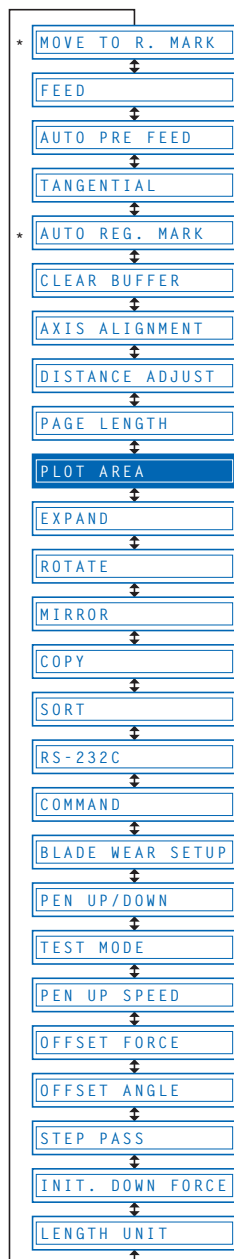
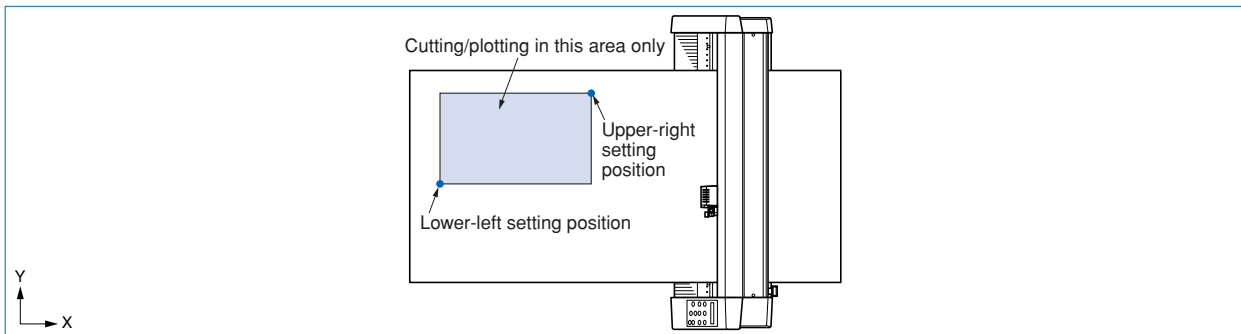

*: Option

Step 1

Press the **⏸ (PAUSE)** key to switch to PAUSE mode.

Step 2

Press the **⏪ (NEXT)** or **⏩ (PREV.)** key until the following menu is displayed.



Step 3

Press the **⏵ (ENTER)** key to display the plotting-area menu.



Step 4

Use the **⬅**, **➡**, **⬆**, and **⬇** (**POSITION**) keys to move the pen to the lower-left setting position, and then press the **⏵ (ENTER)** key. The coordinates of the lower-left position set are displayed. To make the default setting, press the **⊕ (ORIGIN)** key.

Step 5

Once the lower-left position has been set, the coordinates for the upper-right position are displayed. Set these coordinates in the same way as for the lower-left position.

Step 6

Press the **⏸ (PAUSE)** key to cancel PAUSE mode.

CHECKPOINT

The following message is displayed if the lower-left and upper-right settings are not separated by a distance of at least 5 mm. If this message appears, reset the lower-left and upper-right positions.

WRONG PLOT AREA

4.12 Expanding the Cutting/Plotting Area

This function allows the width of the cutting/plotting area to be extended by 9.5 mm on both sides, for a total increase of 19 mm, enabling cutting to be performed up to the area in which the pinch rollers are positioned.

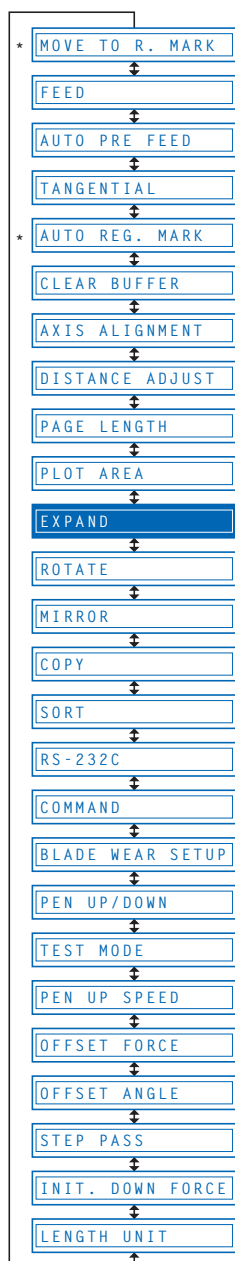

*: Option

Step 1

Press the **⏸ (PAUSE)** key to switch to PAUSE mode.

Step 2

Press the **⏪ (NEXT)** or **⏩ (PREV.)** key until the following menu is displayed.

EXPAND

Step 3

Press the **⏵ (ENTER)** key to display the plotting-area width-setting menu.

EXPAND OFF

Press the **⬆** or **⬇** key to select “ON” or “OFF,” and then press the **⏵ (ENTER)** key to confirm. To cancel the selection, press the **⏪ (NEXT)** or **⏩ (PREV.)** key.

Step 4

If the settings are not changed, press the **⏸ (PAUSE)** key to cancel PAUSE mode. If the settings are changed, the media-type selection menu is displayed.

ROLL2 PRESS ENTR

Step 5

For details on the media loading and selection procedures, refer to “2.3 Loading the Medium.”

4.13 Rotating the Coordinate Axes

This function allows the cutting/plotting origin and coordinate axes to be rotated as shown below.

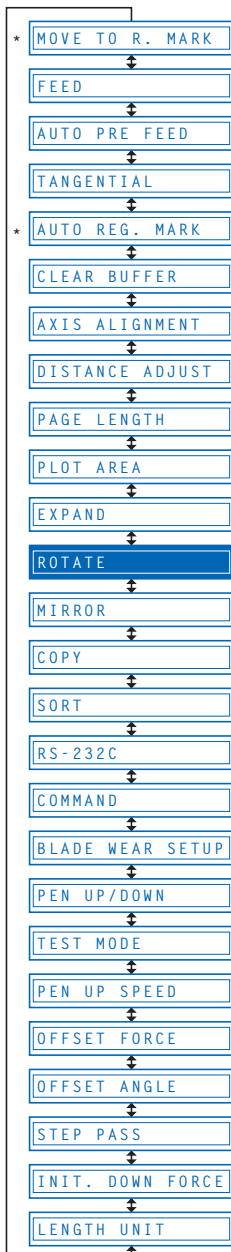
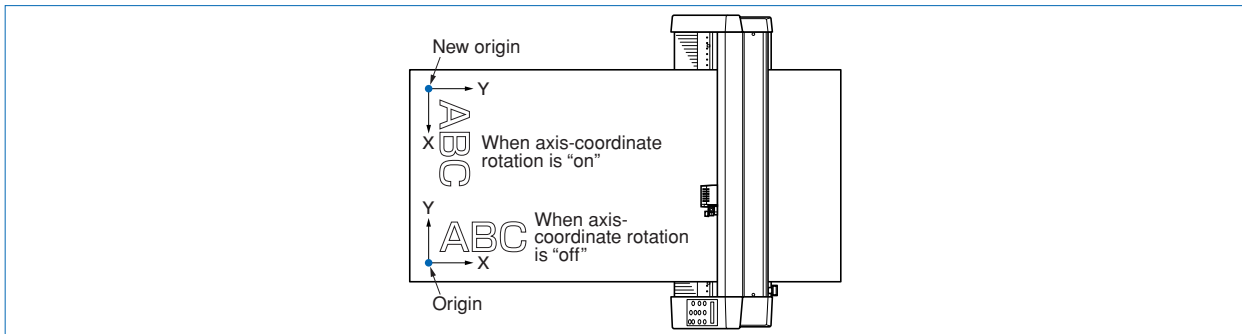

*: Option

Step 1

Press the **⏸ (PAUSE)** key to switch to PAUSE mode.

Step 2

Press the **⏪ (NEXT)** or **⏩ (PREV.)** key until the following menu is displayed.

ROTATE

Step 3

Press the **⏵ (ENTER)** key to display the coordinate-axis rotation-setting menu.

ROTATE OFF

Press the **⬆** or **⬇** key to select “ON” or “OFF,” and then press the **⏵ (ENTER)** key to confirm. To cancel the selection, press the **⏪ (NEXT)** or **⏩ (PREV.)** key.

Step 4

Press the **⏸ (PAUSE)** key to cancel PAUSE mode.

CHECKPOINT

This setting is retained in the memory even when the power is turned off.

When ON is selected for ROTATE, MIRROR is set to OFF.

4.14 Mirroring

This function allows the cutting/plotting origin and coordinate axes to be changed, as shown below.

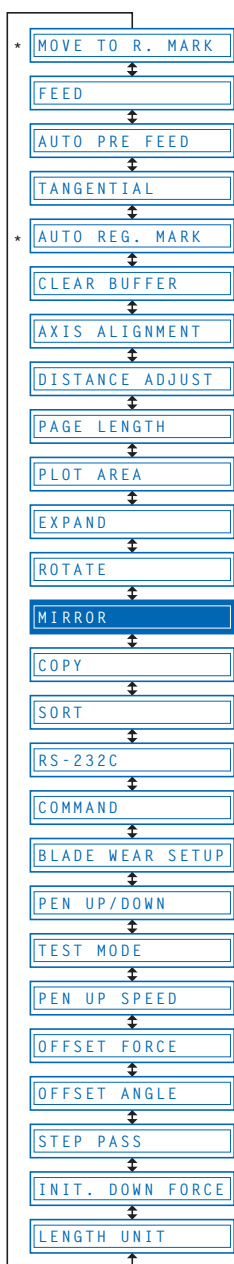
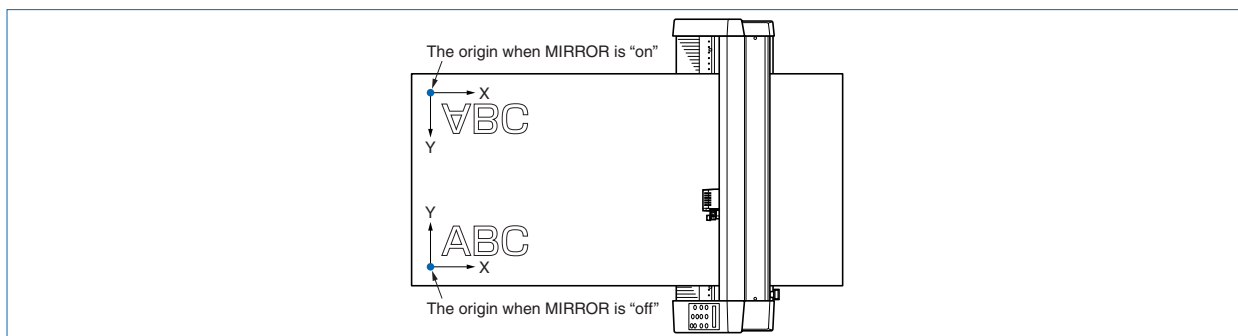

*: Option

Step 1

Press the **⏸ (PAUSE)** key to switch to PAUSE mode.

Step 2

Press the **⏪ (NEXT)** or **⏩ (PREV.)** key until the following menu is displayed.



Step 3

Press the **⏵ (ENTER)** key to display the Mirror setting.



Press the **⬆ (UP)** or **⬇ (DOWN)** key to select "ON" or "OFF," and then press the **⏵ (ENTER)** key to confirm. To cancel the selection, press the **⏪ (NEXT)** or **⏩ (PREV.)** key.

Step 4

Press the **⏸ (PAUSE)** key to cancel PAUSE mode.

CHECKPOINT

- This setting is retained in the memory even when the power is turned off.
- When ON is selected for MIRROR, ROTATE (coordinate-axis rotation) is set to OFF.
- Auto mark reading cannot be performed when MIRROR is set to ON.

4.15 Cutting/Plotting Using the Buffer Memory (COPY Function)

This function is used to make duplicate copies of cutting or plotting data that has been sent from the computer and is retained in the cutting plotter's internal memory.

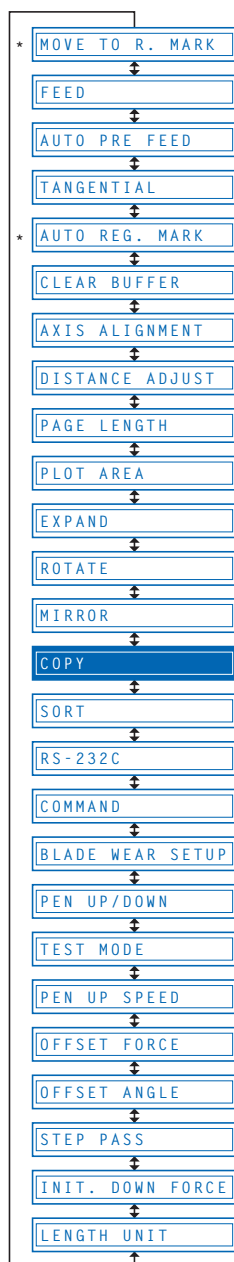
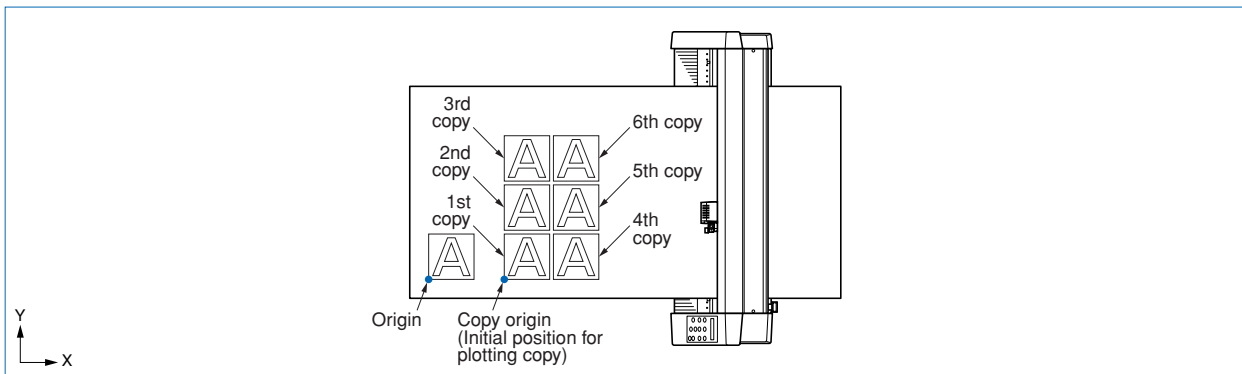

*: Option

Step 1

Send the data to be copied to the cutting plotter, and cut or plot the data once.

Step 2

Use the **◀**, **▶**, **▲**, and **▼** (**POSITION**) keys to move the pen to the starting position for cutting or plotting.

Step 3

Press the **⏸** (**PAUSE**) key to switch to PAUSE mode.

Step 4

Press the **⏪** (**NEXT**) or **⏩** (**PREV.**) key until the following menu is displayed.

COPY

Step 5

Press the **↵** (**ENTER**) key to display the copy-setting menu.

COPY COUNT 1

Step 6

Use the **▲** or **▼** key to select the desired number of copies, and then press the **↵** (**ENTER**) key to confirm. To cancel the selection, press the **⏪** (**NEXT**) or **⏩** (**PREV.**) key.

Step 7

The cutting/plotting operation starts for the number of copies selected.

Step 8

To make further copies, replace the medium and repeat steps 2 to 6.

If the data to be copied does not fit within the cutting/plotting area, the following message is displayed in step 5.

CANNOT COPY

Use the ◀, ▶, ▲, and ▼ (**POSITION**) keys to change the initial copying position or load a medium with an area of sufficient size to fit the copied data.

CHECKPOINT 

- If the initial cutting/plotting position was moved from the original origin, the new origin will also apply during the copying operation. To prevent wasteful use of the medium, the initial cutting/plotting position for the data should be as close as possible to the origin.
 - If the cutting plotter receives another set of data during the copying operation, the operation will not be properly completed because the initial data is cleared during the operation. Do not send new data to the cutting plotter while copying is in progress.
 - If new data is sent to the cutting plotter more than 10 seconds after the initial cutting data is sent, the original data will be cleared from the internal memory.
 - Copying will not be possible if data exceeding approx. 1.6 Mbytes is sent to the cutting plotter, as the data will cause the buffer memory to overflow.
-

4.16 Sorting Settings

This function sorts and cuts or plots the cutting/plotting data stored in the buffer memory to minimize the amount of medium feed required. This is useful for data requiring a large number of movements on the drawing with the pen raised. If the data received has been sorted using the application software, sorting the data using the cutting plotter may require additional time. Turning this function off may speed up the process.

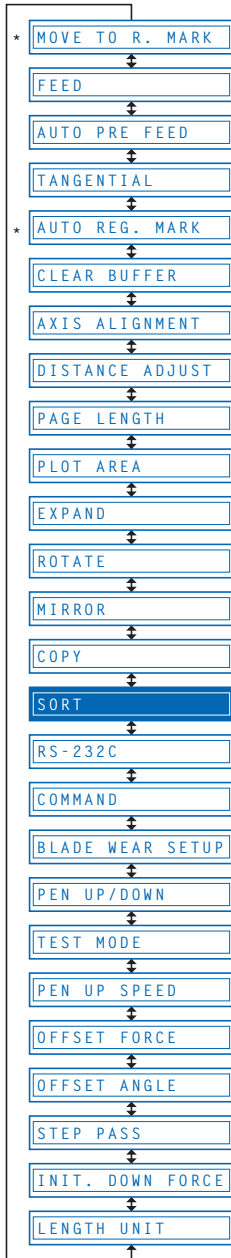

*: Option

Step 1

Press the **⏸ (PAUSE)** key to switch to PAUSE mode.

Step 2

Press the **⏪ (NEXT)** or **⏩ (PREV.)** key until the following menu is displayed.



Step 3

Press the **↵ (ENTER)** key to display the sorting setting menu.



Press the **▲** or **▼** key to select "ON" or "OFF," and then press the **↵ (ENTER)** key to confirm. To cancel the selection, press the **⏪ (NEXT)** or **⏩ (PREV.)** key.

Step 4

Press the **⏸ (PAUSE)** key to cancel PAUSE mode.

CHECKPOINT

- This setting is retained in the memory even when the power is turned off.
- If data for which the cutting/plotting sequence has been set using the application software is received, the cutting/plotting sequence may be changed if this function is set to "ON." The function should be set to "OFF" in this case.

4.17 Interface Settings

If the RS-232C serial interface is used, the interface conditions must be set to ensure that the data-transfer rate (baud rate), parity, data length and handshake settings for the cutting plotter match those set in the application software or computer operating system. This section describes the interface conditions for the cutting plotter. For details on how to set the conditions for your application or computer operation system, refer to the manual provided with the application or operating system.

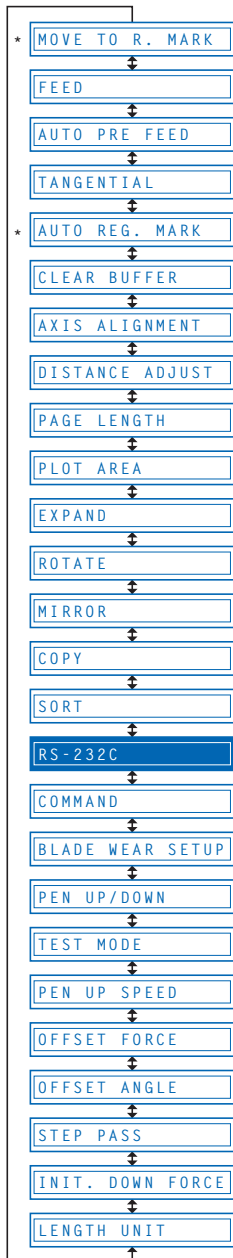

Step 1

Press the **⏸ (PAUSE)** key to switch to PAUSE mode.

Step 2

Press the **⏪ (NEXT)** or **⏩ (PREV.)** key until the following menu is displayed.

RS - 232 C

Step 3

Press the **⏵ (ENTER)** key to display the interface-condition setting menu.

▶ 9600 N 8 H

The current settings are displayed (from left): transfer rate (baud rate), parity, data length, and handshaking mode.

The baud rate can be set to “19200,” “9600,” “4800,” “2400,” “1200,” “600,” or “300.”

The parity can be set to “N” (None), “E” (Even parity), or “O” (Odd parity).

The data length can be set to 7 or 8 bits.

The handshaking mode can be set to “H” (hard-wired handshaking) or “X” (Xon/Xoff handshaking). “E” (ENQ/ACK handshaking) can also be selected when the command mode is set to HP-GL.

All of these interface conditions must be set to match the corresponding settings in the application software and the computer operating system.

The parameter that can be changed is displayed immediately to the right of the ▶ mark. Use the **◀** or **▶** key to select the parameter to be changed, and use the **▲** or **▼** key to select the setting details. Press the **⏵ (ENTER)** key to confirm. To cancel the selection, press the **⏪ (NEXT)** or **⏩ (PREV.)** key.

Step 4

Press the **⏸ (PAUSE)** key to cancel PAUSE mode.

4.18 Setting the Format of Data to be Received

Before data is sent from the computer, the format (command mode) of data sent by the application software must be checked. The cutting plotter accepts two data formats (command modes): GP-GL (Graphtec) and HP-GL commands. Set the command mode to suit the application used.

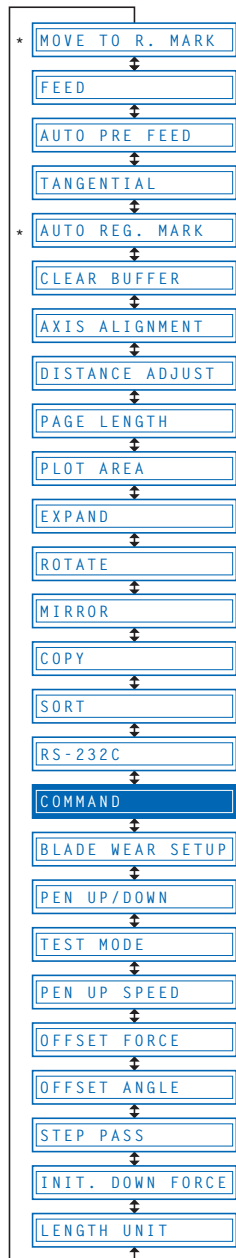

*: Option

■ Setting the Command Mode

Step 1

Press the **⏸ (PAUSE)** key to switch to PAUSE mode.

Step 2

Press the **⏪ (NEXT)** or **⏩ (PREV.)** key until the following menu is displayed.

COMMAND

Step 3

Press the **↵ (ENTER)** key to display the command-setting menu.

COMMAND GP-GL

Step 4

Press the **▲** or **▼** key to select “GP-GL” or “HP-GL,” and then press the **↵ (ENTER)** key to confirm. To cancel the selection, press the **⏪ (NEXT)** or **⏩ (PREV.)** key.

Step 5

If “GP-GL” is selected, set the STEP SIZE. If “HP-GL” is selected, set the ORIGIN POINT. If a command different from that set previously is selected, the PAUSE mode is automatically canceled after STEP SIZE (GP-GL) or ORIGIN POINT (HP-GL) is set.

■ Setting the STEP SIZE

If the GP-GL command mode is set, the minimum unit of distance that the pen can travel can be changed to one of four settings: 0.01 mm, 0.025 mm, 0.05 mm, or 0.1 mm. The default setting is 0.1 mm, so change this setting if your application specifies a different step size.

Step 1

Set the command setting to “GP-GL.”





COMMAND GP - GL

Step 2

Press the  (ENTER) key to display the step-size setting menu.

STEP SIZE 0.100mm

Step 3

Press the  or  key to select “0.100 mm,” “0.050 mm,” “0.025 mm,” or “0.010 mm,” and then press the  (ENTER) key to confirm. To cancel the selection, press the  (NEXT) or  (PREV.) key.

Step 4

Press the  (PAUSE) key to cancel PAUSE mode.

■ Setting the ORIGIN POINT

If the HP-GL command mode is set, the origin point can be set to the lower left or center. The default setting is the lower left, so change this setting if your application specifies a different origin position.

Step 1

Set the command setting to “HP-GL.”

COMMAND HP - GL

Step 2

Press the  (ENTER) key to display the origin-point setting.

ORIGIN PT L.L.

Step 3

Press the  or  key to select “L.L. (LOWER LEFT)” or “CENTER,” and then press the  (ENTER) key to confirm. To cancel the selection, press the  (NEXT) or  (PREV.) key.

Step 4

Press the  (PAUSE) key to cancel PAUSE mode.

4.19 Blade Wear Detection (When Blade Wear Setup is On)

This function calculates the total cutting distance of the cutter blade to indicate when it requires replacement. This should be used purely as a guide, as the actual cutter-blade wear will vary depending on the material cut and the cutting conditions (e.g., force) used.

The pen setting areas are grouped together, and the total distances are calculated for each group. Eight groups can be managed, and they initially correspond to the pen setting areas, so that group 1 corresponds to setting area 1, group 2 corresponds to setting area 2, and so on. If two or more setting areas are combined in a single group, the total calculated distance for that group will be the sum of the individual area values.

It is also possible to include weighting factors for each setting area to correspond to the different wear rates for different materials and cutting conditions. For example, if setting areas 1, 2, and 3 are combined into one group with respective total distances of A, B, and C, and the respective factors are 0.7, 1.2, and 1.0, the total distance for this group will be $A \times 0.7 + B \times 1.2 + C \times 1.0$.

Wear detection can be switched on or off using the special function settings (see “Enabling/Disabling Wear Detection” on page 5-3). When disabled, it is not displayed on the PAUSE menu.

If the power is turned off while cutting is in progress, the cutting distance for that operation is not included in wear-detection calculations.

■ Checking the Wear Rate

Step 1

Check to confirm that the cutting plotter is in READY mode (displaying the current pen settings).



1 PEN 12 30 2

Step 2

Press the  (NEXT) key to display the wear-rate menu for the group to which the above setting area belongs.



BLADE WEAR 60%

The wear rate is shown as 0% for a new pen, and 100% when the total distance exceeds the maximum distance for the cutter blade. Press the  (PREV.) key to return to READY mode.

Step 3

The following message is displayed in READY mode if the wear rate exceeds 100% for the group to which the current setting area belongs.



EXCEEDS 100%

This indication should be used as a guide for cutter-blade replacement.

This display reverts to the normal READY-mode display when the  (PREV.) key is pressed, but it will reappear when the power is turned on again or if a setting area is selected again for a group with a wear rate exceeding 100%.

Always zero the total distance display after replacing a cutter blade (see “Clearing the Total Distance (Wear Rate)”). The display above will disappear, and the distance calculation will restart from zero.

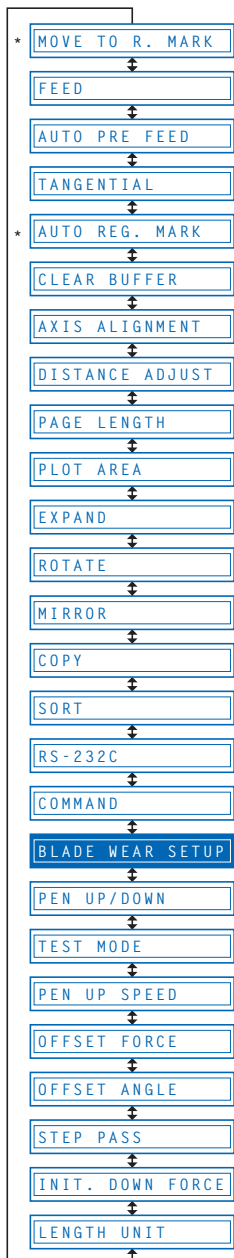

*: Option

■Setting Wear-Rate Groups

This registers setting areas in groups.

Step 1

Press the **⏸ (PAUSE)** key to switch to PAUSE mode.

Step 2

Press the **⏪ (NEXT)** or **⏩ (PREV.)** key until the following menu is displayed.

BLADE WEAR SETUP

Step 3

Press the **⏵ (ENTER)** key to display the wear-rate setting submenu.

SET BLADE GROUP

Step 4

Press the **⏵ (ENTER)** key to display the wear-rate group setting.

GROUP 1 2 4 5

Step 5

The number on the left is the group number, and the numbers to the right of this indicate the setting areas belonging to it, separated by spaces. The display above indicates setting areas 1, 2, 4, and 5, belonging to group 1.

Use the **⏪** or **⏩** key to move the cursor to the group number or setting-area number to be set. Pressing the **⏴** or **⏵** key at the group-number position increases or decreases the number, and pressing the **⏴** or **⏵** key at the setting-area number position displays or doesn't display the number. Select the required group number, display the setting-area numbers to be registered, and then press the **⏵ (ENTER)** key to confirm.

Each setting area can only be registered in one group. To register a setting area in another group, it must first be removed from the group in which it is registered. Initially, setting area 1 is set to group 1, setting area 2 to group 2, and so on, so setting areas must be removed from one group before being registered in another.

To cancel the selection(s), press the **⏪ (NEXT)** or **⏩ (PREV.)** key.

■ Setting Wear-Rate Factors

This sets factors corresponding to the differences in wear rates due to different materials and cutting conditions.

Step 1



Press the  (PAUSE) key to switch to PAUSE mode.

Step 2

Press the  (NEXT) or  (PREV.) key until the following menu is displayed.

BLADE WEAR SETUP

Step 3

Press the  (ENTER) key to display the wear-rate setting submenu, and then press the  (NEXT) or  (PREV.) key until the following menu is displayed.







FACTOR

Step 4

Press the  (ENTER) key to display the wear-rate factor setting.

COND 1 1.00

Step 5

Use the  or  key to increase or decrease the setting-area number, and use the  or  key to increase or decrease the factor value. The factor can be set to between 0.10 and 1.00 in 0.10 intervals, and between 1.00 and 2.50 in 0.25 intervals. Once the wear-rate factor is set, press the  (ENTER) key to confirm. To cancel the selection(s), press the  (NEXT) or  (PREV.) key.

Step 6

Press the  (PAUSE) key to cancel PAUSE mode.

■ Clearing the Total Distance (Wear Rate)

Always zero the total-distance display when a cutter blade has been replaced. This starts the total-distance calculation from zero.

Step 1



Press the  (PAUSE) key to switch to PAUSE mode.

Step 2

Press the  (NEXT) or  (PREV.) key until the following menu is displayed.

BLADE WEAR SETUP

Step 3

Press the  (ENTER) key to display the wear-rate setting submenu, and then press the  (NEXT) or  (PREV.) key until the following menu is displayed.







CLEAR GROUP

Step 4

Press the  (ENTER) key to display the wear-rate clear menu.

CLEAR GROUP1<YES>

Step 5

The number to the right of “CLEAR GROUP” is the group number. Use the  or  key to increase or decrease the group number, and press the  or  key to select “YES” or “NO.” Select “YES” for the group number to be cleared, and press the  (ENTER) key to clear the total distance. To cancel the selection(s), press the  (NEXT) or  (PREV.) key.

Step 6

Press the  (PAUSE) key to cancel PAUSE mode.

4.20 Raising and Lowering the Pen

This function raises and lowers the pen.

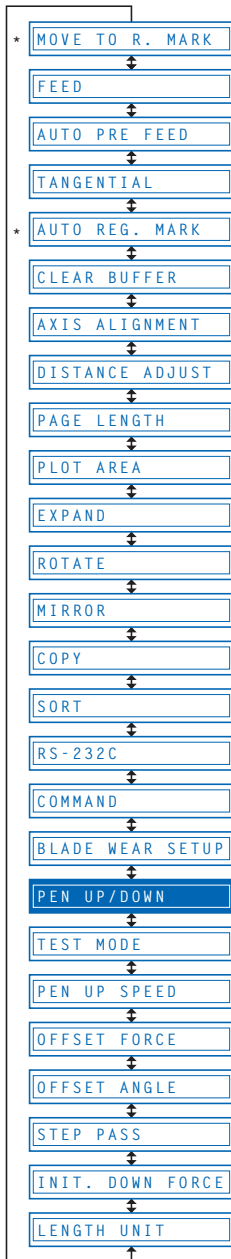

*: Option

Step 1

Press the **⏸ (PAUSE)** key to switch to PAUSE mode.

Step 2

Press the **⏪ (NEXT)** or **⏩ (PREV.)** key until the following menu is displayed.



Step 3

Press the **⏴ (ENTER)** key to lower the pen, and press the **⏵ (ENTER)** key again to raise it.

4.21 TEST Mode

The cutting plotter has five test modes: “**Condition print (COND. PAT.)**” for the printing of setting details, “**Dump mode**” for checking data transfers from the computer, and “**Cutting force test cutting (PRESS TEST CUT)**” for performing five test cuts. These should be used to check the various settings and to check for problems.

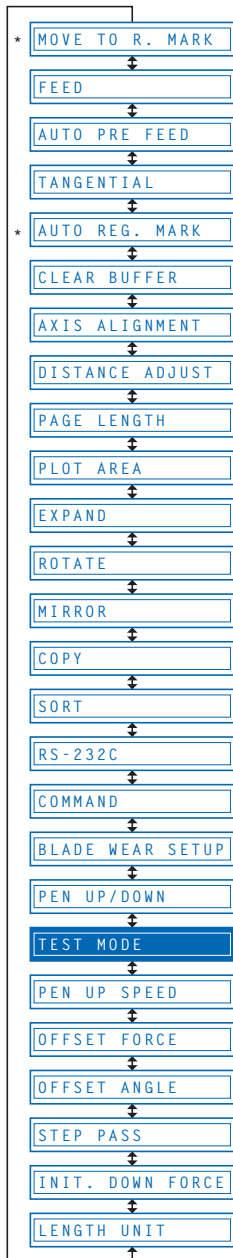

*: Option

■ Condition-List Printing

This function prints out the setting details currently in use.

Step 1

Mount a plotting pen in the pen carriage, and set the conditions to suit the pen used (e.g., force, pen speed settings) (see “3.3 Setting the Cutter-Pen Conditions”).

CHECKPOINT

Load the medium so that it passes over the media sensor.

Step 2

Load an A3-size or larger medium.

Step 3

Press the **⏸ (PAUSE)** key to switch to PAUSE mode.

Step 4

Press the **⏪ (NEXT)** or **⏩ (PREV.)** key until the following menu is displayed.

TEST

Step 5

Press the **↵ (ENTER)** key to display the test-mode submenu.

COND. PAT.

Step 6

Press the **↵ (ENTER)** key to start printing the condition list.

⚠ CAUTION The pen carriage begins moving as soon as this function is set. Keep your hands and other objects away from the cutting plotter’s moving parts.

■ Dump Mode

This function checks whether data is sent correctly from the computer. If the output data does not match the program after the dump list has been output, check the transfer conditions and connections.

Step 1

Mount a plotting pen in the pen carriage, and set the conditions to suit the pen used (e.g., force, pen speed settings) (see “3.3 Setting the Cutter-Pen Conditions”).



Load the medium so that it passes over the media sensor.

Step 2

Load an A4-size or larger medium.

Step 3

Press the (PAUSE) key to switch to PAUSE mode.

Step 4

Press the (NEXT) or (PREV.) key until the following menu is displayed.

TEST

Step 5

Press the (ENTER) key to display the test-mode submenu, and then press the (NEXT) or (PREV.) key until the following menu is displayed.

DUMP

Step 6

Press the (ENTER) key to switch to dump mode.

CHAR DUMP MODE

Step 7

When data is sent to the cutting plotter in this mode, a dump list is printed out. To exit the dump mode, turn on the power again.



The dump list is printed out as ASCII character codes. Characters without codes will be printed as small 2-digit figures. Output data for READ-type commands will be output as dummy data, except for cutting-plotter status output.



CAUTION The pen carriage begins moving as soon as this function is set. Keep your hands and other objects away from the cutting plotter's moving parts.

■ Cutting Force Test Cutting

The cutting force can be changed in one-step increments from its current setting (in the range -2 to +2) to enable five test cuts to be performed. Test cutting can be performed after selecting the TOOL (cutter blade) and specifying the cutter-blade length, OFFSET, FORCE, SPEED, and QUALITY settings to ensure that the selected cutting conditions actually produce the desired cutting results. Check how far the blade cuts into the film and how the corners are being cut. If the cutting results are not satisfactory, reset the cutter-pen conditions and repeat the test cutting until the optimal settings are achieved. Test cutting will be carried out according to the conditions currently set for the cutter-pen.

Step 1

Mount a cutter pen in the pen carriage, and specify cutting conditions suitable for the mounted cutter pen (see “3.3 Setting the Cutter-Pen Conditions.”)

Step 2

Load a sheet of film for cutting.

Step 3



Press the  (PAUSE) key to switch to PAUSE mode.

Step 4

Press the  (NEXT) or  (PREV.) key until the following menu is displayed.

TEST

Step 5

Press the  (ENTER) key to display the Test Mode submenu, and then press the  (NEXT) or  (PREV.) key until the following menu is displayed.

PRESS TEST CUT

Step 6

To change the cutting conditions, press the  (COND.) key to display the conditions setting menu. When you exit the conditions setting menu, the display returns to the menu shown in Step 5. For more information on the conditions setting menu, see “3.3 Setting the Cutter-Pen Conditions.”

Step 7

With the menu shown in Step 5 displayed, press the **(ENTER)** key to start test cutting. Five test cuts will be performed in the range from “-2” to “+2”, with the current FORCE as “0.” Test cutting will be performed from the current pen position.

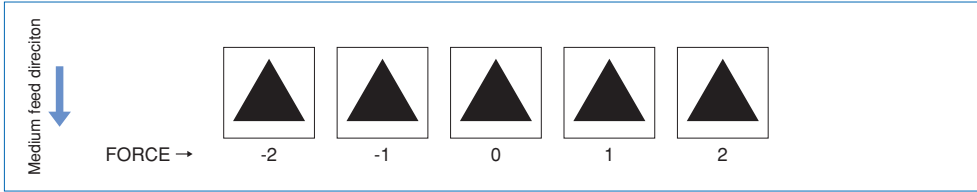

Adjust the OFFSET value to suit the type and thickness of the film being used, and finely adjust the finish of each corner. For the FORCE value setting, make your selection from the five test cuts. In test cutting, adjust the blade length so that the backing sheet is only slightly scored.

Step 8

When test cutting has been completed, the pen carriage moves to the standby position and the following menu is displayed.

PRESS ENTER KEY

Step 9

Press the **(ENTER)** key to return the pen carriage to its previous position and to switch the cutting plotter to READY mode.

Step 10

Upon completion of fine adjustment, send actual cutting data to the cutting plotter for cutting.

CAUTION The pen carriage begins moving as soon as this function is set. Keep your hands and other objects away from the cutting plotter's moving parts.

4.22 Setting the PEN UP SPEED

This function sets the travel speed of the pen when it is raised. It can be specified independently of the cutting SPEED function. When the PEN UP SPEED is high, the pen travels faster when it is raised, thereby reducing the overall cutting time. Your cutting plotter comes with its PEN UP SPEED set to AUTO, which selects the same speed as the cutting SPEED function (pen lowered). Note that if long-axis cutting of a medium is performed with a high PEN UP SPEED setting, the medium is susceptible to jamming.

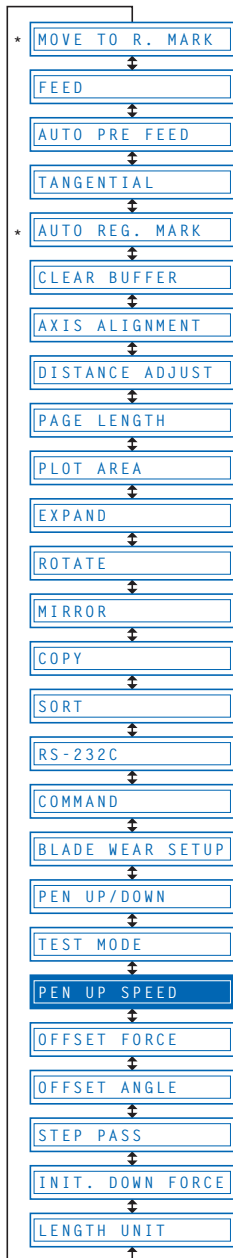

*: Option

Step 1

Press the **⏸ (PAUSE)** key to switch to PAUSE mode.

Step 2

Press the **⏪ (NEXT)** or **⏩ (PREV.)** key until the following menu is displayed.

PEN UP SPEED

Step 3

Press the **⏵ (ENTER)** key to display the pen-up-speed menu.

UP SPEED = AUTO

Use the **▲** or **▼** key to select the value to be set, and then press the **⏵ (ENTER)** key to confirm.

“AUTO” “10” “20” “30” “45” cm/s

To cancel the selection, press the **⏪ (NEXT)** or **⏩ (PREV.)** key.

Step 4

Press the **⏸ (PAUSE)** key to cancel PAUSE mode.

CHECKPOINT

This setting is retained in the internal memory even when the power is turned off.

4.23 Setting the OFFSET FORCE (Initial Cutting Force)

This function specifies the cutting force to be applied during initial blade control for checking the cutter-blade direction at the start of operation. This is used to control the rotation of the cutter-blade tip during initial blade control when thick media is cut, and is therefore not necessary to specify for media of regular thickness. The initial setting is “4.” Increasing this setting increases the cutting force.

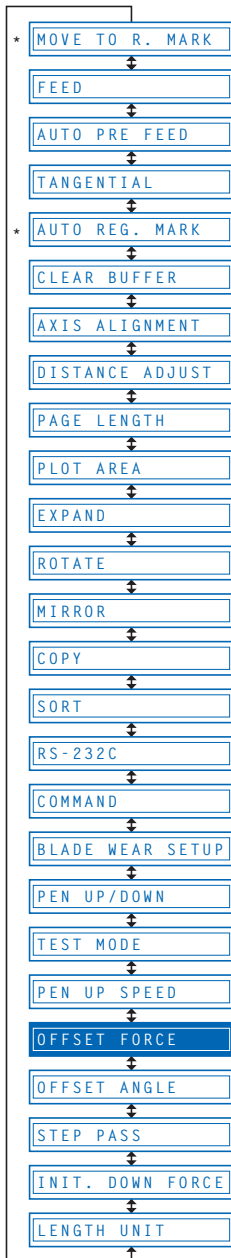

*: Option

Step 1

Press the **⏸ (PAUSE)** key to switch to PAUSE mode.

Step 2

Press the **⏪ (NEXT)** or **⏩ (PREV.)** key until the following menu is displayed.

OFFSET FORCE

Step 3

Press the **⏴ (ENTER)** key to display the offset-force setting menu.

OFFSET FORCE 4

Use the **▲** or **▼** key to select the value to be set, and then press the **⏴ (ENTER)** key to confirm.

“1” to “31”

To cancel the selection, press the **⏪ (NEXT)** or **⏩ (PREV.)** key.

Step 4

Press the **⏸ (PAUSE)** key to cancel PAUSE mode.

CHECKPOINT

This setting is retained in the internal memory even when the power is turned off.

4.24 Setting the OFFSET ANGLE

This function sets the reference value used to adjust the cutter-blade offset angle to correspond to the displacement of the traveling angle as defined by the coordinate movement data received. The cutter blade is controlled above the angle specified. Setting a high value will reduce the total cutting time, but the corners of drawings cut will become rounded and may not be cut precisely. The initial setting is “30.”

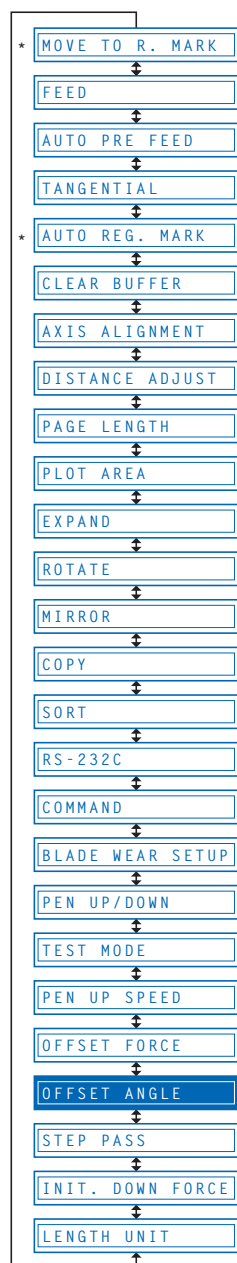

*: Option

Step 1

Press the **⏸ (PAUSE)** key to switch to PAUSE mode.

Step 2

Press the **⏪ (NEXT)** or **⏩ (PREV.)** key until the following menu is displayed.

OFFSET ANGLE

Step 3

Press the **⏵ (ENTER)** key to display the offset-angle setting menu.

OFFSET ANGLE 30

Use the **▲** or **▼** key to select the required value within the range of “0” to “60,” and then press the **⏵ (ENTER)** key to confirm. To cancel the selection, press the **⏪ (NEXT)** or **⏩ (PREV.)** key.

Step 4

Press the **⏸ (PAUSE)** key to cancel PAUSE mode.

CHECKPOINT

This setting is retained in the internal memory even when the power is turned off.

4.25 Setting the STEP PASS

Reducing this setting increases image quality by enabling smooth cutter-blade tip control when arcs are cut. The STEP PASS setting specified is used as the unit for blade tip control, with blade tip control omitted for any data below the STEP PASS setting. If the STEP PASS setting is too high, the image cut may not be faithfully reproduced. Normally, the STEP PASS setting should be set to “1.”

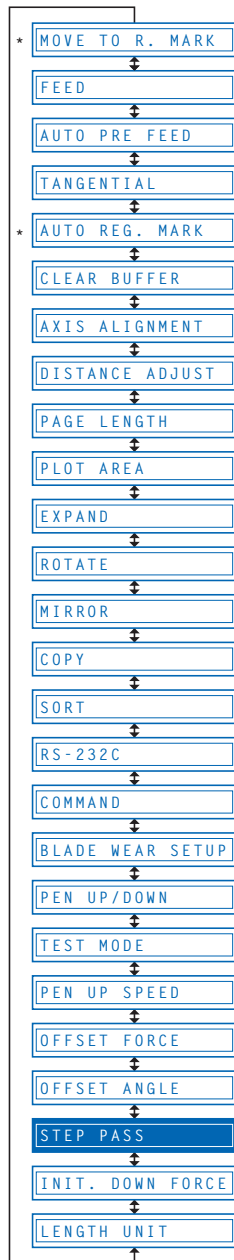

Step 1

Press the **⏸ (PAUSE)** key to switch to PAUSE mode.

Step 2

Press the **⏪ (NEXT)** or **⏩ (PREV.)** key until the following menu is displayed.

STEP PASS

Step 3

Press the **⏴ (ENTER)** key to display the step-pass setting menu.

STEP PASS 1

Use the **▲** or **▼** key to select the required value within the range of “0” to “20,” and then press the **⏴ (ENTER)** key to confirm. To cancel the selection, press the **⏪ (NEXT)** or **⏩ (PREV.)** key.

Step 4

Press the **⏸ (PAUSE)** key to cancel PAUSE mode.

CHECKPOINT

This setting is retained in the internal memory even when the power is turned off.

4.26 Setting the Initial Down Force

The initial down-force setting is useful when TANGENTIAL mode is selected (for the cutting of thick media). With thick film, additional time is required for the cutter blade to penetrate the film fully, even when the necessary cutting force is applied. The cutting operation starts before the cutter blade has fully penetrated the film, causing uncut sections to be left. When the initial down force is specified, this force is used as the cutting force immediately after lowering of the pen when TANGENTIAL mode is selected, enabling the cutter blade to penetrate the medium rapidly. (If the cutting force is 25 and the initial down force is 4, for example, the cutting force applied immediately after lowering of the pen will be 29.) Set the initial down force to suit the type of film used by performing test cuts.

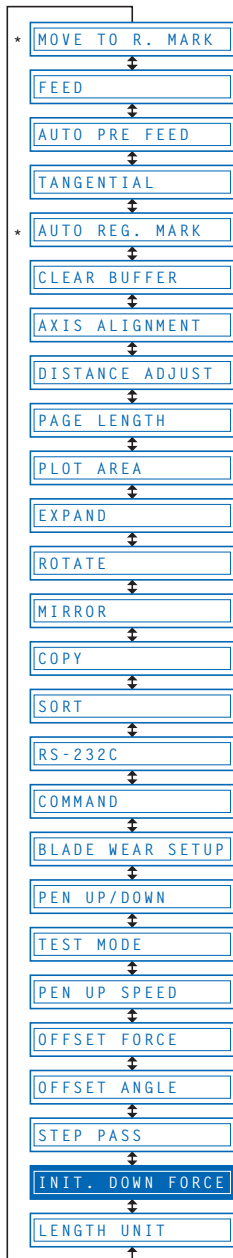

*: Option

Step 1

Press the **⏸ (PAUSE)** key to switch to PAUSE mode.

Step 2

Press the **⏪ (NEXT)** or **⏩ (PREV.)** key until the following menu is displayed.

INIT. DOWN FORCE

Step 3

Press the **⏵ (ENTER)** key to display the initial-cutting-force setting menu.

INIT. DOWN F. 0

Use the **▲** or **▼** key to select the required value within the range of “0” to “20,” and then press the **⏵ (ENTER)** key to confirm. To cancel the selection, press the **⏪ (NEXT)** or **⏩ (PREV.)** key.

Step 4

Press the **⏸ (PAUSE)** key to cancel PAUSE mode.

4.27 Setting the LENGTH UNIT

This function specifies the units for coordinates displayed in millimeters or inches.

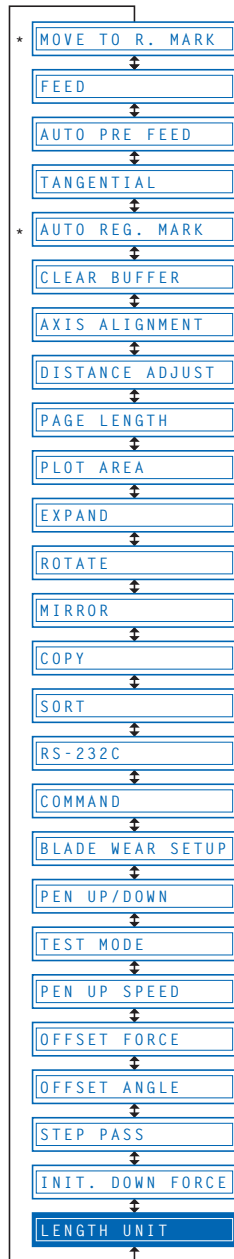

*: Option

Step 1

Press the **⏸ (PAUSE)** key to switch to PAUSE mode.

Step 2

Press the **⏪ (NEXT)** or **⏩ (PREV.)** key until the following menu is displayed.



Step 3

Press the **⏴ (ENTER)** key to display the length-unit menu.



Press the **▲** or **▼** key to select “mm” or “inch,” and then press the **⏴ (ENTER)** key to confirm. To cancel the selection, press the **⏪ (NEXT)** or **⏩ (PREV.)** key.

Step 4

Press the **⏸ (PAUSE)** key to cancel PAUSE mode.

5

Setting and Using the Special Functions

| | | |
|-----|--|-----|
| 5.1 | Description of Special Functions A | 5-2 |
| 5.2 | Setting Special Functions A | 5-4 |
| 5.3 | Description of Special Functions B | 5-4 |
| 5.4 | Setting Special Functions B | 5-5 |

5.1 Description of Special Functions A

The cutting plotter is provided with the special functions described below. These functions are specified only in special situations, and are not normally used.

■ Enabling/Disabling the “:” and “;” Commands (when the COMMAND setting is GP-GL)

This function enables or disables the “:” and “;” commands when the COMMAND setting is GP-GL. If the first part of the data is lost, these commands may be having an adverse effect. In this case, set this function to DISABLED (the default setting is ENABLED).

■ Moving the Pen While Raised or Lowered in Response to the “W” Command (when the COMMAND setting is GP-GL)

This function selects whether, upon receipt of the “W” command for the drawing of arcs, the cutting plotter moves the pen to the specified starting position, raised or in the pen status (raised or lowered) that was in effect immediately prior to receipt of the “W” command.

When PEN DOWN is selected, the pen is moved to the starting position for the drawing of arcs in the pen status (raised or lowered) that was in effect immediately prior to receipt of the “W” command.

When PEN UP is selected, the pen is moved to the starting position for the drawing of arcs in the raised status. This setting is only effective if a cutter blade has been selected in the cutter-pen settings.

(The default setting is PEN UP.)

■ Model ID Response (when the COMMAND setting is HP-GL)

This function sets the response to the “OI” command when the COMMAND setting is HP-GL.

When 7550 is set, the “OI” command response is 7550.

When 7586 is set, the “OI” command response is 7586.

(The default setting is 7550.)

■ SETTING PRIORITY

This function sets whether the cutting plotter places priority on the cutting conditions specified through command input from the computer or through manual settings (on the cutting-plotter control panel).

When MANUAL is selected, cutting is performed using the cutting conditions set at the control panel, and cutting conditions sent from the computer are ignored.

When COMD (COMMAND) is selected, cutting is performed using the cutting conditions specified in a received cutting-condition command. If no commands are received, cutting is performed using the cutting conditions set at the control panel.

(The default setting is MANUAL.)

■ Blade-Tip Initial Position Setting

The cutter blade is placed on the medium to orient it after the power is turned on or the cutter-pen conditions are set. This is referred to as “initializing” the cutter blade.

This function sets the “Blade-Tip Initial Position” for this operation.

When 2 mm is selected, initial blade control is performed at a position 2 mm below the cutting start position.

When OUTSIDE is selected, initial blade control is performed outside of the effective cutting/plotting area.

(The default setting is 2 mm.)

■ Enabling/Disabling PEN UP MOVE

This function sets whether the pen will travel to each point specified or only from the initially specified point to the last specified point when consecutive commands are received specifying pen movement while it is raised.

When ENABLED is selected, the pen travels consecutively to each coordinate specified by the data received.

When DISABLED is selected, the pen travels directly from the initially specified point to the last specified point.

(The default setting is DISABLED.)

■ Enabling/Disabling the Media Sensors

This function sets the media sensors that detect the size of the medium in the feed direction.

When ENABLED is selected, the feed-direction media sensors are enabled.

When DISABLED is selected, the feed-direction media sensors are disabled.

(The default setting is ENABLED.)

■ Enabling/Disabling the Home Sensors

This function sets the home sensors that detect the width of the medium.

When ENABLED is selected, the home sensors are enabled.

When DISABLED is selected, the home sensors are disabled.

(The default setting is ENABLED.)

■ Circle-Command Resolution Setting (when the COMMAND setting is HP-GL)

This function sets whether the resolution is automatically set or fixed at a constant 5 degrees when a cutting-plotter circle command is output while the COMMAND setting is HP-GL.

(The default setting is Auto.)

■ Enabling/Disabling Blade Wear Detection

When ENABLED is selected, the blade wear-detection setting is enabled and the blade wear-detection setting menu is displayed in the PAUSE menu.

When DISABLED is selected, the blade wear-detection setting is disabled, and the blade wear-detection setting menu is removed from the PAUSE menu and is not displayed. For details on wear detection, refer to see “4.19 Blade Wear Detection.”

(The default setting is DISABLED.)

 **CAUTION** If the media or home sensors have been disabled (set to DISABLED), be sure to specify the cutting/plotting area (see “4.11 Setting the Cutting/Plotting Area”). If the cutting/plotting area is not specified, the cutting mat may be damaged.



5.2 Setting Special Functions A

Step 1

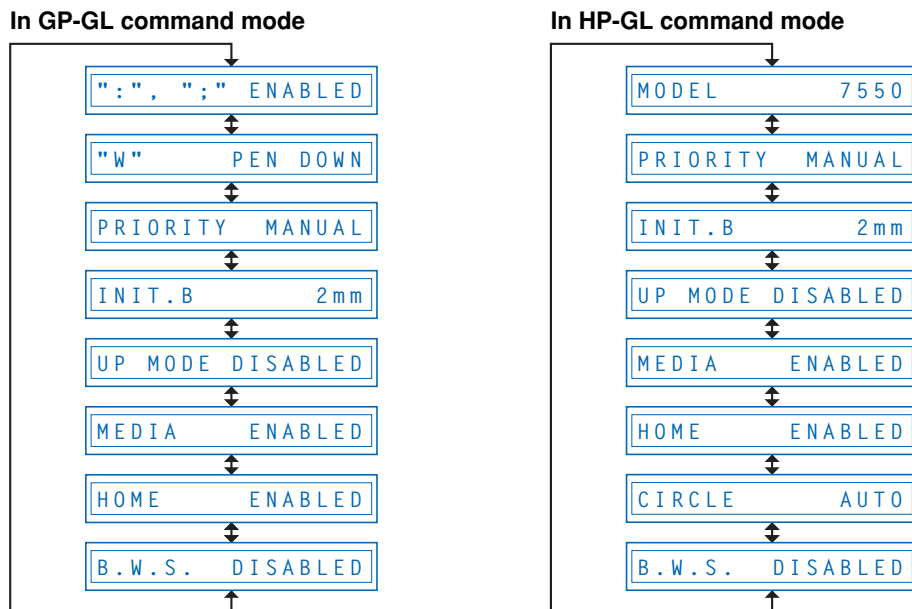



Turn on the cutting plotter while holding down the  key. The menus for setting the special functions are displayed.



Step 2

Scroll up or down to select the required menu using the  (NEXT) or  (PREV.) key.

Step 3

Select the setting details using the  or  key, and press the  (ENTER) key to register the setting. To cancel the selection, press the  (NEXT) or  (PREV.) key. The next menu is displayed.

Step 4

Once all the settings have been made, turn off the cutting plotter.

5.3 Description of Special Functions B



These functions are specified only in the special situations described below, and are not normally used.

■ Display Language Setting (MENU LANGUAGE SELECTION)

This function sets the language used on the display. One of six languages can be selected: English, French, German, Italian, Spanish, or Japanese.





5.4 Setting Special Functions B

Step 1

Turn the cutting plotter on while holding down the  (**ENTER**) and  (**ORIGIN**) keys simultaneously. The special functions B setting menu is displayed.

DISPLAY ENGLISH

Step 2

Use the  or  key to select the desired display language, and then press the  (**ENTER**) key to confirm. To cancel the selection, press the  (**NEXT**) or  (**PREV.**) key.

Step 3

Once all the settings have been made, turn off the cutting plotter.

6

TROUBLESHOOTING

| | | |
|------------|---|------------|
| 6.1 | The Cutting Plotter Does Not Operate When Turned On..... | 6-2 |
| 6.2 | The Cutting Plotter Does Not Operate Correctly..... | 6-2 |
| 6.3 | The Cutting Results Are Unsatisfactory | 6-3 |
| 6.4 | An Error Message Was Displayed..... | 6-5 |

6.1 The Cutting Plotter Does Not Operate When Turned On

| Symptom | Cause | Solution |
|---|--|--|
| The STATUS lamp on the control panel does not light up. | Power is not being fed to the cutting plotter. | Check to confirm that the power cord is securely connected to the cutting-plotter AC line inlet and the electrical outlet. |
| The STATUS lamp on the control panel lights up, but nothing appears on the display panel. | The cutting plotter is defective. | Contact your sales representative or nearest Signwarehouse dealer. |

6.2 The Cutting Plotter Does Not Operate Correctly

| Symptom | Cause | Solution |
|--|--|--|
| OFFSCALE is displayed when data is received. Some areas cannot be cut. | The data received lies outside the cutting/plotting area set. | Set the cutting/plotting area (see “4.11 Setting the Cutting/Plotting Area”). Check the page-length setting (see “4.10 Setting the PAGE LENGTH”). |
| | The data received is larger than the cutting/plotting area set. | Replace with a larger-size medium. Reduce the data size. |
| Cannot maintain the cutting conditions Cannot change the cutting conditions | The cutter-pen condition-setting priority is set to PROGRAM. | Set the condition setting priority to MANUAL (see “5.1 Description of Special Functions A” and “5.2 Setting Special Functions A”). |
| | ENTER was not pressed after the settings were changed. | Check the operation and reset the cutter-pen conditions (see “3.3 Setting the Cutter-Pen Conditions”). |
| “LOAD MEDIA” is displayed even when the medium has been loaded. | The medium is semi-transparent and is not detected by the media sensors. | Set the media-sensor setting to DISABLE, and set the cutting/plotting area (see “5.1 Description of Special Functions A” and “5.2 Setting Special Functions A”). |
| | The medium is not detected by the media sensors due to strong reflected light. | Change the lighting direction and avoid direct sunlight. |
| | The medium is not loaded so that it passes the media sensors. | Load so that the medium passes over the media sensors. |
| | The right-hand pinch roller is not positioned over the right-hand long grit roller. | Position the right-hand pinch roller over the right-hand long grit roller. |
| The medium is skewed. | The left-hand pinch roller is not positioned over the left-hand grit roller. | Position the left-hand pinch roller over the left-hand grit roller. |
| | The medium was loaded at an angle. | Reload the medium. |
| | The length of the medium to be cut was not drawn out first when the medium was loaded. | Draw out the required length of roll medium to be used. |
| The medium is suddenly fed forward. | The selections for medium loading are incorrect. | Check the medium selection (ROLL1 PRESS ENTR, ROLL2 PRESS ENTR, SHEET PRESS ENTR). |

| Symptom | Cause | Solution |
|---|---|---|
| Abnormal noise is generated by the cutter during cutting. | The cutter plunger tip is in contact with the medium. | Adjust the cutter-blade extension (see “2.4 Adjusting and Mounting the Cutter Pen”). Reduce the cutting force (see “3.3 Setting the Cutter-Pen Conditions”). |
| The “No Media” error message is displayed during a cutting/plotting operation and operation is halted. | “Paper End” was detected erroneously. | Press the “ENTER” key to continue cutting/plotting and to disable any subsequent “Paper End” detection. To enable subsequent “Paper End” detection, lower the media set lever and perform a feed operation. |

6.3 The Cutting Results Are Unsatisfactory

| Symptom | Cause | Solution |
|--|--|---|
| The cut corners are too rounded or too pointed. | The cutter offset does not match the blade type used. | Adjust the cutter offset value (see “3.3 Setting the Cutter-Pen Conditions”). Corners are rounded: Increase the value. Corners are pointed: Reduce the value. |
| The medium curls up at the corners. | The blade offset angle is too small. | Increase the offset angle (see “4.24 Setting the OFFSET ANGLE”). |
| | The blade is extended too far. | Adjust the blade extension length (see “2.4 Adjusting and Mounting the Cutter Pen”). |
| | The cutter offset does not match the blade type used. | Adjust the offset (see “3.3 Setting the Cutter-Pen Conditions”). |
| | The cutting speed is too high. | Reduce the cutting speed (see “3.3 Setting the Cutter-Pen Conditions”). |
| | The blade is dull. | Replace the cutter blade (see “3.3 Setting the Cutter-Pen Conditions”). |
| Only the initial section cut is satisfactory. | The cutter blade is not rotating smoothly in the holder. | Clean inside the holder. |
| | The offset force is insufficient. | Increase the offset force (see “4.23 Setting the OFFSET FORCE”). |
| | The CB09UA spring is missing. | Replace the blade with a spring attached. |
| The cutter blade does not completely cut lines that should be solid (blade skips). Solid lines are not cut at a constant depth (mild skipping). | The blade is extended too far. | Adjust the blade extension length (see “2.4 Adjusting and Mounting the Cutter Pen”). |
| | The cutting speed is too high. | Reduce the cutting speed (see “3.3 Setting the Cutter-Pen Conditions”). |
| Curved lines have coarse resolution. | The cutting data is too coarse. | Correct so that the application data is output with greater detail. |
| | The blade offset angle is too small. | Increase the offset angle (see “4.24 Setting the OFFSET ANGLE”). |
| Characters or complex figures are deformed. | The step-pass setting is too large. | Reduce the step-pass setting (see “4.25 Setting the STEP PASS”). |

| Symptom | Cause | Solution |
|---|--|---|
| The cutting start and end points for figures do not match. | The data is not connected. | Check by plotting using a pen, and correct the data. |
| | The offset force is too low. | Increase the offset force (see “4.23 Setting the OFFSET FORCE”). |
| | The film is too flimsy. | Use a stiffer film. |
| | The cutter blade is not rotating smoothly in the holder. | Clean inside the holder. |
| Cannot cut to the specified size | The step size for the software and the cutting plotter do not match. | Adjust the step-size settings so that they match (see “3.1 Setting the Format of Data to be Received”). |
| | Scaling has been specified in the software. | Check the scaling. |
| The length cut differs from that specified. | The medium is slipping. | Reduce the cutting speed (see “3.3 Setting the Cutter-Pen Conditions”). Reduce the pen-up speed (see “4.22 Setting the PEN UP SPEED”). |
| | The distance correction is not correct. | Adjust the distance correction (see “4.9 Distance Adjustment”). |
| The medium is discolored where the blade cut. | The cutter plunger tip is in contact with the medium. | Adjust the blade extension length (see “2.4 Adjusting and Mounting the Cutter Pen”). Reduce the cutting force (see “3.3 Setting the Cutter-Pen Conditions”). |
| The cutter blade cuts into the backing sheet. | The blade is extended too far. | Adjust the blade extension length (see “2.4 Adjusting and Mounting the Cutter Pen”). |
| | The cutting force is too high. | Reduce the cutting force (see “3.3 Setting the Cutter-Pen Conditions”). |
| The medium is cut, but it is difficult to weed afterward. The cut medium cannot be picked up using a retack sheet. | The retack sheet is not sufficiently adhesive. | Use a retack sheet with greater adhesion. |
| | The medium becomes entangled after cutting. | Adjust the blade extension length (see “2.4 Adjusting and Mounting the Cutter Pen”). Reduce the cutting force (see “3.3 Setting the Cutter-Pen Conditions”). |
| | Weeding of the cut medium was left too long. | Weed the cut medium promptly. |
| Characters and lines are deformed when plotted using the pen. | A blade has been selected in the cutter-pen settings. | Select PEN (see “3.3 Setting the Cutter-Pen Conditions”). |
| An unintentional L shape is cut. | “2 mm (BELOW)” has been selected for the INT.B (Blade-tip Initial Position) setting. | Select “OUTSIDE” for the INT.B (Blade-tip Initial Position) setting. (see “5.1 Description of Special Functions A” and “5.2 Setting Special Functions A”) |

6.4 An Error Message Was Displayed

| Symptom | Cause | Solution |
|---|--|--|
| CURRENT LIMIT or POSITION ALARM is displayed. The STATUS lamp flickers. | The cutting conditions are not suitable for the medium being cut. | Reduce the cutting speed. Reduce the cutting force (see "3.3 Setting the Cutter-Pen Conditions"). |
| | Excessive load is causing the current to the motor to exceed the rated value. | Remove the obstruction and turn the cutting plotter back on. |
| | The pen carriage movement is being obstructed. | |
| | The pen carriage was subjected to external pressure during cutting. | |
| | Scraps of the medium in the moving parts are impeding operation. | |
| If this problem occurs frequently, contact your sales representative or nearest Signwarehouse dealer. | | |
| SPEED ERROR is displayed. The STATUS lamp flickers. | The pen carriage was subjected to external pressure after the power was turned on. | Turn the cutting plotter off and then back on again. |
| | The internal speed control is faulty. | |
| | If this problem occurs frequently, contact your sales representative or nearest Signwarehouse dealer | |

If any of the following command error messages appear, they are nearly always caused by one of the following two reasons:

- The software or host-computer settings have been changed.
- The cutting-plotter interface settings have been changed.

Solutions

- Configure the settings in the software menu so that the menu can control the cutting plotter.
- Set the host-computer interface conditions correctly.
- Set the cutting-plotter interface conditions correctly (see “3.1 Setting the Format of Data to be Received”).
- Make sure that the data-transmission conditions match.

Error messages in GP-GL command mode

| Error message | Cause | Solution |
|----------------------|--|--|
| GP-GL ERROR 1 | An unrecognizable command was received. | |
| | Noise was received when the computer was turned on. | Press the ENTER key to cancel the error. |
| | The software command settings for controlling the cutting plotter have been changed. | Set the software command settings for controlling the cutting plotter. |
| | The data-transmission settings have been changed in the interface settings. | Set the correct data-transmission conditions. |
| GP-GL ERROR 2 | The command terminator is incorrect. | |
| | The software settings for the output device have been changed. | Set the software command settings for controlling the cutting plotter. |
| | The data-transmission settings have been changed in the interface settings. | Set the correct data-transmission conditions. |
| GP-GL ERROR 3 | The command delimiter is incorrect. | |
| | The software settings for the output device have been changed. | Set the software command settings for controlling the cutting plotter. |
| | The data-transmission settings have been changed in the interface settings. | Set the correct data-transmission conditions. |
| GP-GL ERROR 4 | The command parameter exceeds the permissible range. | |
| | The software settings for the output device have been changed. | Set the software command settings for controlling the cutting plotter. |
| | The data-transmission settings have been changed in the interface settings. | Set the correct data-transmission conditions. |
| GP-GL ERROR 5 | An error occurred in the reception of data within the interface. | |
| | The software command settings for controlling the cutting plotter have been changed. | Set the software command settings for controlling the cutting plotter. |
| | The data-transmission settings have been changed in the interface settings. | Set the correct data-transmission conditions. |

Error messages in HP-GL command mode

| Error message | Cause | Solution |
|-----------------------|--|--|
| HP-GL ERROR 1 | An unrecognizable command was received. | |
| | Noise was received when the computer was turned on. | Press the ENTER key to cancel the error. |
| | The software command settings for controlling the cutting plotter have been changed. | Set the software command settings for controlling the cutting plotter. |
| | The data-transmission settings have been changed in the interface settings. | Set the correct data-transmission conditions. |
| HP-GL ERROR 2 | The command was executed with the wrong parameters. | |
| | The software settings for the output device have been changed. | Set the software command settings for controlling the cutting plotter. |
| | The data-transmission settings have been changed in the interface settings. | Set the correct data-transmission conditions. |
| HP-GL ERROR 3 | The command parameter is incorrect. | |
| | The software settings for the output device have been changed. | Set the software command settings for controlling the cutting plotter. |
| HP-GL ERROR 5 | An unrecognizable character set was specified. | |
| | The software settings for the output device have been changed. | Set the software command settings for controlling the cutting plotter. |
| HP-GL ERROR 6 | The command coordinates specified are outside the cutting/plotting area. | |
| | The software settings for the output device have been changed. | Set the software command settings for controlling the cutting plotter. |
| HP-GL ERROR 7 | The buffer overflowed when the downloadable-character buffer or polygon buffer was used. | |
| | The software settings for the output device have been changed. | Set the software command settings for controlling the cutting plotter. |
| HP-GL ERROR 10 | Another output command was executed while a command was already being executed. | |
| | An invalid command was received following an ESC code. | Set the software command settings for controlling the cutting plotter. |
| | An invalid byte was received within a device control command. | |
| | A parameter outside the permissible range was specified in an I/O command. | |
| | There were too many parameters in an I/O command. | |
| | A framing error, parity error, or overrun error occurred. | Set the correct data-transmission conditions. |
| | The interface buffer overflowed. | |

APPENDIX

| | | |
|-------------------|-----------------------------------|------------|
| Appendix A | Main Specifications | A-2 |
| Appendix B | Options and Supplies | A-3 |
| Appendix C | External Dimensions | A-4 |
| Appendix D | Menu Tree | A-5 |

Appendix A Main Specifications

| Item | Vinyl Express Qe60+ |
|-------------------------------------|---|
| CPU | 32-bit CPU |
| Configuration | Grit rolling |
| Drive system | Digital servo |
| Maximum cutting area | 603 mm x 50 m |
| Range of guaranteed precision | 584 mm x 5 m ^{*1} |
| Compatible media widths | Minimum: 50 mm Maximum: 712 mm (28 inches) |
| Maximum media thickness | 10 mil |
| Maximum cutting speed | 60 cm/s (45° direction) |
| Maximum acceleration | 21.2 m/s ² (45° direction) |
| Specifiable cutting speeds | 1–10, 15, 20, 25, 30, 35, 40, 45 cm/s |
| Cutting force | 0.2-2.9N (20 gf to 300 gf) (31 levels) |
| Minimum character size | Approximately 5 mm for alphanumeric characters (varies depending on the medium, font, etc.) |
| Mechanical resolution | 0.005 mm |
| Programmable resolution | GP-GL: 0.1/0.05/0.025/0.01 mm; HP-GL TM *2: 0.025 mm |
| Repeatability precision | 0.1 mm or less per 2 m ^{*1} |
| No. of pens mountable | 1 pen |
| Compatible cutter type | Supersteel cutter blades |
| Compatible pen type | Water-based fiber-tip pens |
| Compatible cutting film | Marking film (PVC, fluorescent, or reflective film) up to 0.25 mm in thickness (excluding high-luminosity reflective film) |
| Interfaces | RS-232C/USB (Full Speed) |
| Buffer capacity | 2 MB |
| Command modes | GP-GL, HP-GL TM *2 (selected on the control panel) |
| Display panel | Liquid crystal display (16 characters x 1 row) |
| Rated power supply | 100 to 240 V AC, 50/60 Hz |
| Power consumption | 100 VA |
| Operating environment | 10°C to 35°C, 35% to 75% RH |
| Conditions for guaranteed precision | 16°C to 32°C, 35% to 70% RH |
| External dimensions (W x D x H) | Approx. 851 x 585 x 1004 mm |
| Weight (including stand) | Approx. 25 kg |

*1: Varies depending on the type of Signwarehouse-authorized film and the cutting conditions

*2: HP-GLTM is a registered trademark of Hewlett-Packard Company.

Appendix B Options and Supplies

■ Options

| Designation | Part No. | Description |
|-------------|-------------|--------------------------------|
| Basket | PG0022 | Basket for Vinyl Express Qe60+ |
| Loupe | PHP-61LOUPE | Loupe with 6x magnification |

■ Supplies

| Designation | Part No. | Description |
|---------------------------|-------------|--|
| Cutter holder | PHP32-CB09N | 1 holder for the 0.9-mm-diameter supersteel blade |
| | PHP32-CB15N | 1 holder for the 1.5-mm-diameter supersteel blade |
| Cutter blade | CB09UA-5 | Set of 5 0.9-mm-diameter supersteel blades |
| | CB15U-5 | Set of 5 1.5-mm-diameter supersteel blades |
| | CB15UB-5 | Set of 5 1.5-mm-diameter supersteel blades for cutting detailed characters |
| Water-based fiber-tip pen | KF550-F8 | 1 pen each in red, black, violet, brown, blue, green, orange, and pink |
| | KF550-S1 | 2 black pens and 1 pen each in red, blue, and green |
| | KF551-RD | 5 red pens |
| | KF552-BK | 5 black pens |
| | KF555-BL | 5 blue pens |
| | KF556-GR | 5 green pens |
| | | |

Appendix C External Dimensions

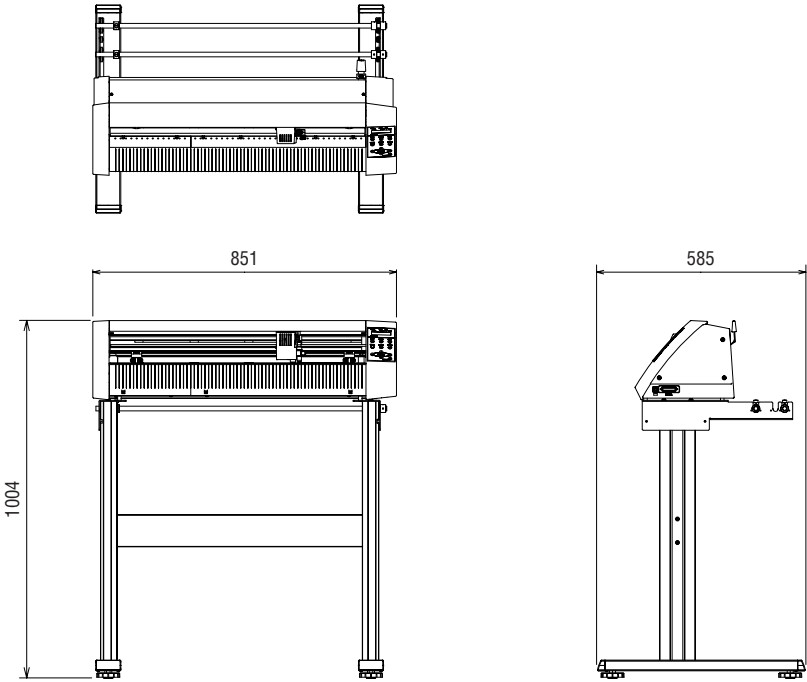

Units: mm
Dimensional accuracy: ± 5 mmS

Appendix D Menu Tree

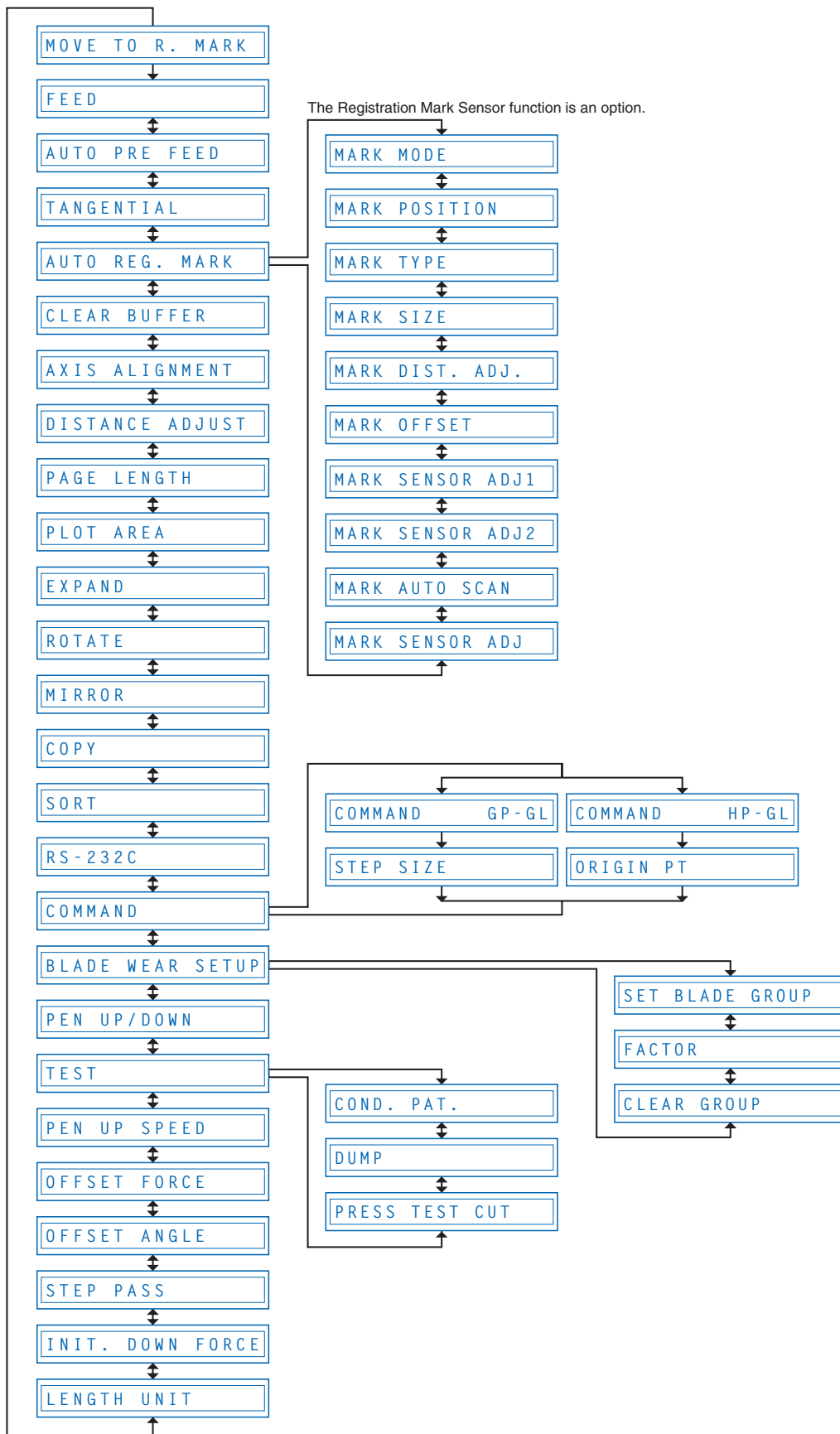

Note: "MOVE TO R. MARK" is applied only for RMS model (option).
 "AUTO REG. MARK" is applied only for RMS model (option).

INDEX

A

- AC power cord 1-2
- AC power inlet..... 1-3
- Accessories..... 1-2
- Adjusting the blade length..... 2-12
- Adjusting the registration-mark reading
 - sensor (1)..... 4-17
- Adjusting the registration-mark reading
 - sensor (2)..... 4-18
- Adjusting the Sensitivity
 - of the Registration-Mark Sensor 4-21
- Aligning the coordinate axes..... 4-23
- Aligning the push rollers..... 2-8
- An error message was displayed..... 6-5
- AUTO PRE-FEED..... 4-5
- Auto-registration-mark-reading settings..... 4-8

B

- Blade-tip initial position setting..... 5-2

C

- Checking the wear rate 4-38
- Circle-command resolution setting..... 5-3
- Clearing the buffer memory 4-22
- Clearing the total distance (wear rate) 4-40
- COND. 1-4
- Condition-list printing 4-43
- Connecting to your computer..... 2-2
- Control panel..... 1-4
- Cutter blade (CB09UA) 1-2
- Cutter plunger 1-2
- Cutter-pen construction..... 2-11
- Cutting Force Test Cutting 4-45
- Cutting mat..... 1-3
- Cutting/plotting using the buffer memory (COPY function) 4-32

D

- Description of special functions 5-2, 5-4
- Display language setting..... 5-4
- Displaying the effective cutting area 3-9
- Distance adjustment 4-25
- Drawing origin point 4-10
- Dump mode 4-44

E

- Enabling/disabling blade wear detection5-3
- Enabling/disabling PEN UP MOVE.....5-3
- Enabling/disabling
 - the “:” and “;” commands5-2
- Enabling/disabling the home sensors5-3
- Enabling/disabling the media sensors5-3
- ENTER..... 1-4
- Error messages in GP-GL command mode.....6-6
- Error messages in HP-GL command mode.....6-7
- Expanding the cutting/plotting area 4-29
- External dimensions A-4

G

- GP-GL ERROR.....6-6
- Grit roller 1-3

H

- HP-GL ERROR.....6-7

I

- Indicator lamp 1-4
- Interface settings 4-35

L

- Loading the medium2-4
- Loading the roll medium2-5

M

- Main specifications A-2
- Media cutter 1-2
- Media set lever 1-3
- Medium and registration-mark position.....4-9
- Menu tree..... A-5
- Mirroring.....4-31
- Model ID response.....5-2
- Moving the pen3-9
- Moving the pen carriage
 - in +100 mm steps3-12
- Moving the pen while raised or lowered in response to the “W” command (when the COMMAND setting is GP-GL)5-2

N

NEXT 1-4

O

Optimal cutting conditions
for each media type 3-5
Options A-3
Options and supplies A-3
ORIGIN 1-4
Origin point 4-16

P

Parts names and functions 1-3
PAUSE 1-4
PAUSE menu list 4-2
Pen carriage 1-3
Pen holder 1-3
POSITION 1-4
PREV. 1-4
Push rollers 1-3

Q

Quick start manual 1-2

R

Raising and lowering the pen 4-42
Reading range required for the detection of
registration marks 4-9
Reading the Auto Registration Marks 4-3
Reference pen conditions for plotting pens 3-5
Registration-mark mode 4-10, 4-11
Registration-mark pattern 4-9
Registration-mark size 4-14
Replacing the cutter blade 2-11
Roll-medium 1-2
Rotating the coordinate axes 4-30

S

Serial (RS-232C) interface connector 1-3
Setting FORCE 3-8
Setting OFFSET 3-7
SETTING PRIORITY 5-2
Setting QUALITY 3-9
Setting special functions 5-4, 5-5
Setting SPEED 3-8
Setting the command mode 3-2, 4-36

Setting the cutter-pen 3-5
Setting the cutting/plotting area 4-28
Setting the FEED function 4-4
Setting the format of data
to be received 3-2, 4-36
Setting the initial cutting position
(origin point) 3-10
Setting the interface conditions 3-4
Setting the LENGTH UNIT 4-52
Setting the OFFSET ANGLE 4-49
Setting the OFFSET FORCE
(initial cutting force) 4-48
Setting the ORIGIN POINT 3-3, 4-37
Setting the PAGE LENGTH 4-27
Setting the PEN UP SPEED 4-47
Setting the Registration-mark
Auto-scan mode 4-20
Setting the registration-mark distance
adjustment 4-15
Setting the registration-mark pattern 4-13
Setting the STEP PASS 4-50
Setting the STEP SIZE 3-3, 4-37
Setting TOOL (cutter blade or pen) 3-7
Sorting 4-34
Stand 1-2
STATUS 1-4
Stock rollers 2-4
Stop function 3-11
Storing and selecting cutter-pen-condition
setting areas 3-6
Supplies A-3

T

TANGENTIAL mode 4-6
TEST 1-4
Test cutting 3-12
TEST mode 4-43
The cutting plotter does not
operate correctly 6-2
The cutting plotter does not
operate when turned On 6-2
The cutting results are unsatisfactory 6-3
The initial down force 4-51
Troubleshooting 6-1
Turn the blade-length adjustment 2-11
Turning on the power 2-3
Types and features of cutter blades 2-10

U

| | |
|-------------------------------|-----|
| USB interface connector | 1-3 |
| User Guide CD-ROM | 1-2 |

W

| | |
|---------------------------------|------|
| Water-based fiber-tip pen | 1-2 |
| Wear detection | 4-38 |
| Wear-rate groups | 4-39 |

The specifications, etc., in this manual are
subject to change without notice.

VEXQe6+-UM-151

Aug 10, 2006 1st edition

Signwarehouse.com
